

Advanced Dungeons & Dragons®

Official Game Adventure

the forest oracle

by Carl Smith



Crops wilt, leaves wither on the trees, and animals must leave the once-fertile Downs valley or die. All who dwell there must abandon their homes or perish -- unless your party can lift the curse. For 6-8 characters, levels 2-4.



TSR, Inc.

PRODUCTS OF YOUR IMAGINATION™

ADVANCED DUNGEONS & DRAGONS and PRODUCTS OF YOUR IMAGINATION are trademarks owned by TSR, Inc.

The Great Olde Woode

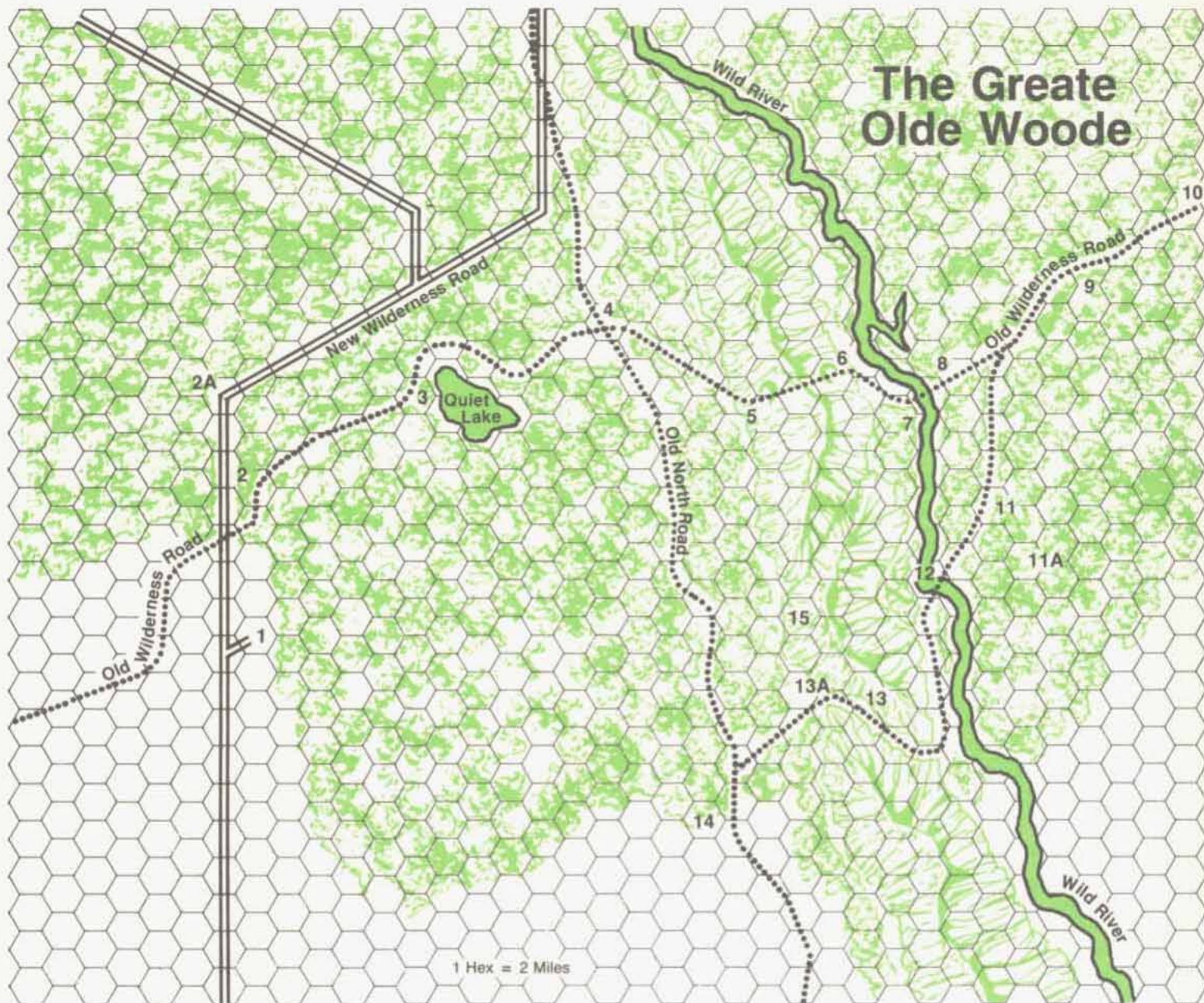

Key

- | | |
|----------------------------|-----------------------|
| 1. The Downs | 9. Castle Karn |
| 2. The Brigands | 10. The Forest Oracle |
| 2A. The Brigand's Hideout | 11. The Bugbears |
| 3. Quiet Lake | 12. The Bugbear Camp |
| 4. The Wildwood Inn | 13. The Yeti |
| 5. The Horns of the Dragon | 13A. The Perytons |
| 6. The Orc Guards | 14. The Gypsy Camp |
| 7. The Dyrad Grove | 15. Olot's Lair |
| 8. The Worgs | |

To Wildwood Inn
Entrance

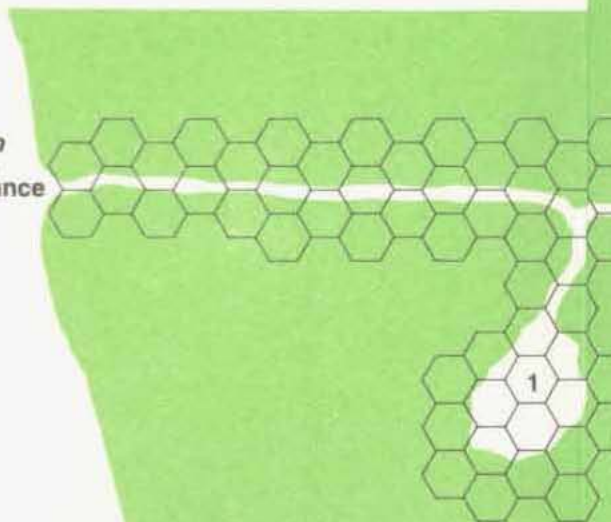

ADVANCED DUNGEONS & DRAGONS®
GAME ADVENTURE N2

the forest oracle

by Carl Smith

Game Adventure for Character Levels 2-4

Only you can save the Downs from the curse!

preface

Seen from the rim of the hill, the vale looks as if a mighty pen has drawn a slash across it. The gentle hillside leading to the valley floor is golden and healthy. The Greate Olde Woode beyond the vale rises in autumn splendor. But the land in between. . .

As you move from the golden grass of the hillside to the blighted valley, you hesitate, wary of setting foot on the brown, wispy grass. Nothing moves within the spoiled land ahead: nothing but rotten fruit dropping from the trees. The soil is gray and cracked as if it had not rained for many days. But the rain has often made travel difficult in the past weeks; this is no drought.

This cannot be the Downs.

Long ago, the land prospered under the care of the Druids that lived here. Fruit tree branches hung low, heavy with ripened apples and pears. Sheep, goats, and cows wandered the grassy slopes surrounding the valley.

But when civilization came, the Druids moved into the heart of the Greate Olde Woode, possibly across the Wild River. If the Druids were here, they could prevent the crops and animals from dying. They could prevent the wildlife from disappearing.

Help for this land lies somewhere within the dark, ancient forest...with the Forest Oracle of the Druids.

Can you reach them in time to save the Downs?

Editor: Anne C. Gray
Graphic Designer: Elizabeth Riedel
Cover Art: Keith Parkinson
Interior Art: Jeff Easley
Cartographer: "Diesel"

Distributed to the book trade in the United States by Random House, Inc., and in Canada by Random House of Canada, Ltd.

Distributed to the toy and hobby trade by regional distributors.

Distributed in the United Kingdom by TSR (UK) Ltd.

This module is protected under the copyright laws of the United States of America. Any reproduction or other use of the material or artwork contained herein is prohibited without the express written permission of TSR, Inc.

ADVANCED DUNGEONS & DRAGONS is a registered trademark owned by TSR, Inc.

© 1984 TSR, Inc. All Rights Reserved.

TSR, Inc.
POB 756
Lake Geneva,
WI 53147



TSR, Inc.

PRODUCTS OF YOUR IMAGINATION™

TSR (UK) Ltd.
The Mill, Rathmore Road
Cambridge CB14AD
United Kingdom

table of contents

Preface	Page 1
Notes to the Dungeon Master	3
A. Into the Greate Olde Woode	4
1. The Opening Scene	4
2. The Happy Farmer Tavern	5
3. Starting the Journey	5
4. The Brigands	6
5. Quiet Lake	6
6. The Pavilion	7
7. The Wildwood Inn	7
8. Robbed	8
9. The Horns of the Dragon	8
10. The Tunnel Under The Dragonteeth Mountains	9
11. The Eastern Exit of The Dragonteeth Mountains	12
B. East of the Dragonteeth Mountains	13
1. The Dryad Grove	13
2. The Wild River	13
3. The West Bank of Wild River	19
4. The Ruins of Castle Karn	19
5. The Forest Oracle of the Druids	20
6. Back to Castle Karn	21
7. Return to Forest Oracle	23
8. The Bugbear Trap	23
9. Crossing Wild River	23
C. Home Again	24
1. Dragonteeth Crossing	24
2. The Last of the Dragonteeth Mountains	25
3. Leaving Dragonteeth Crossing	25
4. Rinaldo	26
5. Madame Riva's Camp	26
6. Olot's Lair	28
7. Back to the Gypsy Camp	29
8. Return to The Downs	29
9. The Downs	30

Maps and Diagrams

The Greate Olde Woode	Inside Front Cover
The Happy Farmer Tavern (Diagram 1A)	15
The Brigand's Camp (Area 2B)	15
Quiet Lake (Area 3)	16
The Quiet Lake Pavilion (Area 3A)	16
Wildwood Inn (Area 4)	16
The Tunnel Through The Horns of The Dragon (Area 5)	Inside Back Cover
The Ruins of Castle Karn (Area 9)	17
The Druids' Oracular Tree (Area 10)	17
The Yeti's Lair (Area 13)	18
Olot's Lair (Area 15)	18
The Greate Olde Woode (Player's Map)	32

notes to the dungeon master

The Forest Oracle is an AD&D module for levels 2-4. It is an independent adventure, and not a part of a series. It can be integrated into any existing campaign, or played as a separate adventure to help initiate players into the world of AD&D.

As Dungeon Master, you should read the game adventure thoroughly before playing. Read only the boxed text to the players. The text that is not boxed is for your use and should only be revealed to the players at your discretion.

When players are asked to make dexterity checks, it means that the characters must roll their dexterity or less on 1d20. The effects of the roll are explained in each case.

ABBREVIATIONS USED IN THIS MODULE

The following abbreviations indicate where you may refer to other sources for more information.

DMG = Dungeon Master's Guide
PH = Player's Handbook
MM = Monster Manual I

ABBREVIATIONS USED IN MONSTER STATISTICS

The following abbreviations are used to present NPC and monster statistics.

AC=Armor Class	SD=Special Defense
MV=Movement	S=Strength
HD=Hit Dice	I=Intelligence
hp=hit points	W=Wisdom
#AT=Attacks/round	Con=Constitution
Dmg=Damage	Ch=Charisma
SA=Special Attack	D=Dexterity

WANDERING MONSTERS

Make a die roll every two turns when the party is in the wilderness to determine if they encounter wandering monsters. A 1 on a 1d20 means the party encounters a wandering monster. Roll 1d20 again and consult the Wandering Monster Table to determine which monster the party encounters. The party surprises the monster(s) if the DM rolls a 1 or 2 on a 1d6, there is no surprise if the

DM rolls a 3 or 4, and the monsters surprise the party if the DM rolls a 5 or 6. If the characters wish to look for the monster lairs, they may. Of course, if they look for the lairs, they will have to leave the trail, and may become lost in the woods.

Adjust the number of wandering monsters encountered to the number of player characters. Limit the number of 1 or 2 Hit Die monsters to twice the number of player characters, and 3+ Hit Die monsters to one per player character. The wandering monsters encountered will always attack.

WANDERING MONSTER TABLE

1. Giant Ant (1-20): AC 3; MV 18"; HD 2; hp 13 each; #AT 1; Dmg 1-6 [mandibles]; SA Warriors have poison sting; SD None
2. Baboon(s) (10-20): AC 7; MV 12"; HD 1+1; hp 7 each; #AT 1; Dmg 1-4 [bite]; SA None; SD Climbing
3. Bears [Black] (1-3): AC 7; MV 12"; HD 3+3; hp 14 each; #AT 3; Dmg 1-3/1-3/1-6 [claw/claw/hug]; SA Bearhug for 2-8 pts.; SD None
4. Boar [Wild] (1-6): AC 7; MV 15"; HD 3+3; hp 12 each; #AT 1; Dmg 3-12 [bite]; SA None; SD None
5. Centipedes [Giant] (2-12): AC 9; MV 15"; HD 1/4; hp 2 each; #AT 1; Dmg None, SA Poison, SD None
6. Dogs [Wild] (4-8): AC 7; MV 15"; HD 1+1; hp 8 each; #AT 1; Dmg 1-4 [bite]; SA None; SD None
7. Frogs [Killer] (3-9): AC 8; MV 6"/12"; HD 1+4; hp 10 each; #AT 3; Dmg 1-2/1-2/2-5 [talons/talons/teeth]; SA Use both talons and teeth in attack; SD None
8. Gnolls (4-8): AC 5; MV 9"; HD 2; hp 12 each; #AT 1; Dmg 2-8 [sword]; SA None; SD None
9. Harpies (2-4): AC 7; MV 6"/15"; HD 3; hp 15 each; #AT 3; Dmg 1-3/1-3/1-6 [claw/claw/club]; SA Singing and Charm; SD None
10. Hyenas (2-6): AC 7; MV 12"; HD 3; hp 12 each; #AT 1; Dmg 2-8 [bite]; SA None; SD None
11. Kobolds (10-40): AC 7; MV 6"; HD 1/2; hp 3 each; #AT 1; Dmg 1-4 [sword]; SA None; SD None
12. Lizard [Giant] (2-4): AC 5; MV 15"; HD 3+1; hp 15 each; #AT 1; Dmg 1-8 [bite]; SA A to hit roll of 20 results in doubling victim's damage; SD None
13. Lizard Man (6-12): AC 5; MV 6"/12"; HD 2+1; hp 12 each; #AT 3; Dmg 1-2/1-2/1-8 [claw/claw/club]; SA Attempt to ambush humans; SD None
14. Men [Cavemen] (10-20): AC 8; MV 12"; HD 1; hp 5 each; #AT 1; Dmg 1-6 [club]; SA None; SD None
15. Orc (10-20): AC 6; MV 9"; HD 1; hp 6 each; #AT 1; Dmg 1-8 [sword]; SA None; SD None
16. Rat [Giant] (5-20): AC 7; MV 12"/6"; HD 1/2; hp 3 each; #AT 1; Dmg 1-3 [bite]; SA Disease; SD None
17. Satyrs (2-4): AC 5; MV 18"; HD 5; hp 21 each; #AT 1; Dmg 2-8 [butt]; SA Butts with sharp horns or 20% chance to play pipes and *charm/sleep* a character and rob him of choice items; SD Surprised only on a 1
18. Skeletons (3-10): AC 7; MV 12"; HD 1; hp 6 each; #AT 1; Dmg 1-6 [spear]; SA None; SD One-half damage from sharp-edged weapons
19. Tigers (1-2): AC 6; MV 12"; HD 5+5; hp 27 each; #AT 3; Dmg 2-5/2-5/1-10 [claw/claw/bite]; SA Rear Claws for 2-8/2-8; SD Surprise only on a 1
20. Wolves [Common] (2-10): AC 7; MV 18"; HD 2+2; hp 14 each; #AT 1; Dmg 2-5 [bite]; SA None; SD None

TRAVEL TIME

A man on foot can travel 20 miles a day, about 2 miles an hour. Each hex is two miles across, so ten hexes may be travelled a day. On horseback a man can travel 40 miles a day or 20 hexes. However, men must dismount and lead the horses through the mountain tunnel.

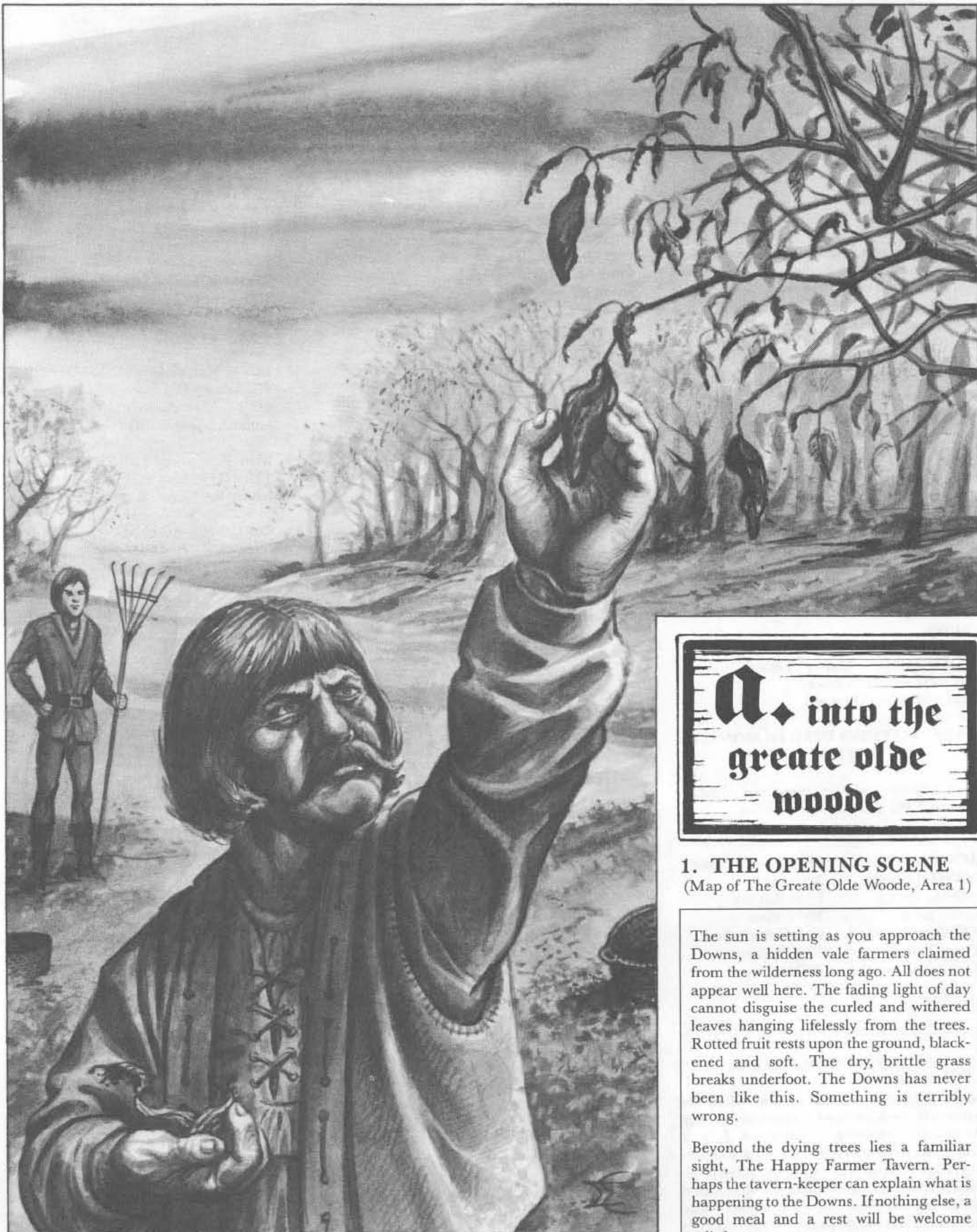

A♦ into the greate olde woode

1. THE OPENING SCENE (Map of The Greate Olde Woode, Area 1)

The sun is setting as you approach the Downs, a hidden vale farmers claimed from the wilderness long ago. All does not appear well here. The fading light of day cannot disguise the curled and withered leaves hanging lifelessly from the trees. Rotted fruit rests upon the ground, blackened and soft. The dry, brittle grass breaks underfoot. The Downs has never been like this. Something is terribly wrong.

Beyond the dying trees lies a familiar sight, The Happy Farmer Tavern. Perhaps the tavern-keeper can explain what is happening to the Downs. If nothing else, a good meal and a rest will be welcome relief.

2. THE HAPPY FARMER TAVERN

"Greetings," says a tall, hefty man as the door to the warm, dimly-lit tavern opens. "Have a seat." He points to some benches surrounding a table in the corner nearest the fire.

The Happy Farmer Tavern (Map 1A) is a small, country tavern. Travellers sleep in the main tavern room, or rent the spare bedroom the keeper of the tavern, Milos Thunderchinn, (Fighter; LV 2; S 12; I 10; W 11; Con 9; C 10) has to offer (See Map 1A).

A friendly man who likes to sell his ale, Milos takes pride in its good quality. He is the very soul of a patient and understanding bartender. His prices are fair, and his cooking is tasty. Milos would not feed his customers anything he would not eat himself.

THE TOWN MEETING

Milos serves a hardy meal at the Happy Farmer Tavern, and offers several glasses of ale to wash it down. The tavern is crowded tonight since a town meeting has been called here. An old man enters the tavern and everyone becomes silent.

The old man is bent and gnarled by time. His hand shakes as it clutches his walking stick. He wears a clean, well-mended robe embroidered with a few colorful moons and stars.

"My friends, I am Delon the Mage. I have lived happily in the Downs for longer than I care to remember. I have seen it grow from a simple farmhouse to an entire community. Crops now grow where long ago none grew, and fruit trees have blossomed where only the wildwood stood.

"But times are changing for the worse. I see the crops withering in the fields. Fruit falls from the trees before ripening, black and rotten. The livestock are not healthy—they now sicken with every day.

"A blight lies upon the Downs. We have been cursed by the gypsy witch who passed this way. Had we given her the silver she wished, or let her rest a while and gather strength, these ills might not have befallen us.

"I see the land turning against us, and I am helpless to remove this curse. My powers are too feeble to spare the land, but perhaps I can hold the curse at bay long enough for you to gather what is left of the harvests. What we will do next year, I do not know. If only I had the powers of a Druid, I could help." He shakes his head sadly.

"I am old, I cannot travel. None of you may leave because crops must be harvested, families cared for, and small businesses tended. It is a difficult undertaking, but perhaps not for the strangers we have before us." His eyes are fixed upon you. "You are our only hope for survival." He stares at you, waiting, and adds, "Those who search for the Druids will have the opportunity for glory and adventure beyond their wildest imaginings." The room becomes deathly still, and most of the townsfolk turn to regard you, the strangers in their midst.

Assuming the party answers Delon's plea for aid, he invites them to his quarters to spend the night and prepare for the journey. He provides them with two weeks' rations. He also gives them a rough, old map of the area, and points out the general direction of the Druids and the Forest Oracle on the map. (Give the map on page 32 to the players.) The party will not find anything worth stealing in Delon's quarters.

The party may purchase standard supplies, which are available in town.

If the party refuses to aid the Downs, the townsfolk will ignore them, aside from providing the services the party pays for. Eventually, the party will be asked to help the Downs or leave.

3. STARTING THE JOURNEY

Early the next morning, the mage explains, "Follow the New Wilderness Road until you reach the Old Wilderness Road." He digs in his pockets and extracts an old talisman. "This is a *talisman of protection from evil*. It may be of help."

THE NEW WILDERNESS ROAD

The New Wilderness Road runs roughly north to south. The Downs lies just off the road below the Great Old Wood. The road is wide enough for two wagons to pass one another, but just barely.

The woods grow closely about the new road. The trees are tall and old. The undergrowth shoves its way between the massive tree trunks, and the area is alive with animal sounds. Inside the wood, foliage blocks the sun, allowing only a few rays to filter down from the leafy canopy. The sun is so filtered and broken that it is hard to tell what time of day it is.

The party can travel on this or any other recognized road and not get lost. If the party leaves the road, they may become lost, and then must follow the standard rules for adventurers who are lost (DMG p. 49). Because of the age of Delon's map, the New Wilderness Road is not shown. The location of the mountains, the river, and the Druid's temple have not changed since the old mage drew the map.

Just after the party enters the woods, they may find the lightly overgrown Old Wilderness Road which runs east-west across the New Wilderness Road. Secretly roll 1d6 for each party member. On a 1-3 they locate the road; if no one sees the road, allow the party to travel for one-half day before they realize they have passed it by. When they return, they should be able to find the road as night falls.

THE OLD WILDERNESS ROAD Map of The Great Old Wood, Area 2)

The Old Wilderness Road is a path which crosses over the New Wilderness Road. Winding and bushy, it has been unused for some time. Grass now grows across the road, and the woodland brush seems to be reclaiming the cleared area.

There are only faint tracks in the dirt, but the party is unable to determine who or what made the prints. There are no other signs of use of this road.

4. THE BRIGANDS

A group of seven men approaches. They are following the road east, and are making good time, neither tarrying nor running. Their faces are expressionless. One is dressed as a cleric of some sort, and another is dressed as a travelling drummer. The others could be peasants or serfs going from one location to another for the harvest season. Each carries some sort of weapon. It is plain that they are not soldiers by their haphazard way of walking. They do not seem to be joking loudly or singing as they advance.

The party encounters seven brigands. One is the leader (Fighter; AC 5; MV 6' per round; HD 3; hp 13; % In Lair 20%; #AT 1; Dmg 1-6 *Sword +1*; SA *Sword +1*; SD Standard), of the other six brigands (Fighters; AC 7; MV 6' per round; HD 1-6; hp 10 each; % In Lair 20%; #AT 1; Dmg 1-6 [sword]; SA None; SD Standard). The brigands look like rough men and carry weapons that pilgrims or wayfarers would not.

The brigands charge when they are 25 feet from the party of adventurers. They are all armed with swords. Roll 1d6. On 1-3 the brigands surprise, on 3-4 there is no surprise, and on 5-6 the party surprises. The brigands will fight until they are all dead, or until the party has been killed. If a brigand is captured, he will offer to lead the party to his hide-out (Area 2A Map) if they spare his life. He will not volunteer any more information about the hideout, but will not lie if asked a direct question about it.

THE BRIGAND'S HIDE-OUT (Map of The Grete Olde Woode, Area 2A)

The New Wilderness Road curves to the east. Just beyond the curve in the road, a small path leads off to the northwest into some trees. About 1,000 feet down the path is a small clearing containing three small dwellings, a larger dwelling, and a large animal pen of some sort.

A guard watches from a patch of wood closest to the road on the north side of the brigand's path. Armed with a sword and spear, the guard (AC 7; MV 12"; HD 1; hp 6; #AT 1; Dmg 2-7 [sword or spear] SA None; SD None) stands a 90% chance of seeing the party if they remain on the path. If the party attempts to come upon the brigand's camp by any manner other than the path, the guard has only a 1 on 1d6 chance of spotting their approach.

If the guard spots the party, he leaves his post to warn the brigands in camp of the party's approach. If he does not see the party, he stays where he is. If the guard is still alive when the party attacks the brigand's camp, he sneaks through the woods to aid his friends by attacking the PCs from the rear, if possible.

The brigands will be surprised if the party was not spotted by the guard. If the guard spotted the party, the brigands will surprise them.

There are 8 brigands in camp at this time. Seven (Fighters; AC 7; MV 12"; HD 1; hp 6 each; #AT 1; Dmg 2-7 [sword]; SA/SD None) brigands sit in front of their huts cleaning their weapons, and the second in command (Fighter; AC 5; MV 12"; HD 2; hp 9; #AT 1; Dmg 1-6 [crossbow or broadsword]; SA None; SD None) sits inside his hut. He is cleaning his crossbow (light) and is wearing a broadsword.

The brigands fight to the death. Their treasures can be found hidden in the huts.

Hut A

Inside lie two dirty, unmade beds, four sacks, a shaky-looking table, and a large wine barrel.

Hut A: Leader and Second-in-Command's hut where most of the treasure is stored. Four sacks of 50 gp, a chest of silver rings, bracelets, and necklaces worth 750 sp, and a wine barrel containing 5,000 cp are kept here. A scroll of *gaseous form* is stuffed inside the leader's pillow.

Hut B

Inside sit two unmade beds and a fireplace with a low fire.

Hut B: There are two beds, a table, and a fireplace inside this hut. A small fire burns in the fireplace. A loose brick can be removed from the fireplace where 50 gp, 100 sp, 500 cp, and a gem (150 gp) are hidden.

Hut C

Two beds with torn blankets, a rough table, and a fireplace furnish this room. No fire burns in the fireplace.

Hut C: A chest that contains 1,000 cp is hidden under the last bed. When the chest is opened, PCs must save vs. Paralyzation as gas fills the room. A thief may attempt to remove the trap on the chest if he is able to detect it.

Hut D

Two beds, an old table, and an empty firewood box furnish this hut. The fireplace has a stone which looks odd, as if not properly mortared.

Hut D: The fireplace has no mantle, but it has a loose stone on its left side. Inside the hole lie three gems worth 100 gp each, and a medallion (no magical value) in the shape of two wings supporting a skull with glass eyes. The medallion is made of silver, and is worth 20 gp.

Area E

Two goats look up from this pen and bleat. The earth in the middle appears torn up, as if someone had been digging there.

Area E: This is the stock corral. There are two goats inside but no treasure. If anyone enters the corral without tying the goats to the sides, the billy goat butts them for 1d4 worth of damage.

5. QUIET LAKE (Map of The Grete Olde Woode, Area 3)

The forest trail is straight. Leaves of countless years pave the path, preventing grass from growing over the road. Squirrels play in the trees and dart across the path. The sun filters down through the trees. A bird sings while another struggles with a worm. All is normal and serene. An old deer skeleton lies on the path amongst scattered paw prints of wolves. The prints and skeleton appear several weeks old.

As the party comes within one mile of Quiet Lake, everything changes. No more birds sing, and little wildlife of any other sort moves. The area becomes strangely different. It does not seem as ominous as sad. When the party approaches Quiet Lake by following the road, they see the lake extending to the southeast.

6. THE PAVILION

A deer lies at the water's edge. Further south stands a small pavilion. (See Area 3A Map.)

The pavilion sits at the edge of the lake, small and slightly raised on stilts. It does not appear to have been lived in for some time. The wood is old, and a few cobwebs hang across the windows. Curtains keep out the sun and block the view inside. The door is tightly closed.

The deer sleeps because a huge *sleep* potion was put in the lake by a jealous nymph. Anyone drinking just one cup from the lake must take a chance on being put to sleep if he is below 4th level. There is a 20% chance that any water carried away from the lake will not work (DMG p. 117). Mixed with the *sleep* potion was a *duration* potion. All who sleep stay so until they are moved away from the edge of the water and the shore; they will then awaken normally. Do not encourage the party to test the water. If they check the deer, they will discover it has a very slight pulse.

The pavilion on the lake shore was built for the nymph's lover. The front door to the pavilion is not locked, nor is the back door. Party members going up the steps to the front door will step on a squeaky board. This alerts no one, but it was here to let Chloe, the nymph, and Evan, her lover, know if they were about to have unannounced guests. The only access to the back door is to go into the water and swim to the door.

INSIDE THE PAVILION

The front door is not locked. The sound of gentle breathing comes from inside.

When the door is opened, sunlight illuminates the room (Map 3A). A young man sleeps on the bed. The room is furnished with two wooden chairs, a table, couch, pantry, bed, chest, and a stack of firewood for the fireplace.

Evan the Forester (Fighter; Lvl 3; AC 6; MV 12"; HD 2; hp 5; #AT 1; Dmg 2-7 [axe]; SA/SD None) sleeps in the pavilion. The nymph who loved him was afraid he was going to leave her so she arranged to have a special *sleep* enchantment cast upon the lake. Evan sleeps until awakened. He awakens in one round as outlined for *sleep* spell (PH p. 68).

In the pantry, the party finds an old, moldy sack of flour, a corked jug of wine, three wooden plates, four wooden spoons, and two pewter mugs. In the chest lie blankets, two candlesticks, tinder and flint, and a dried-out wreath of water lilies which Evan kept as a remembrance of Chloe.

The fireplace has no secret compartments. There is no treasure in the room. Evan owns a longbow and a dagger. The longbow and quiver of 10 arrows rest in the northeast corner of the room. Evan wears his dagger on his belt.

Chloe, the nymph (AC 9; MV 12"; HD 3; hp 15; #AT 0; Dmg nil; SA Blind/kill if victim sees her; SD *Dimension Door*), regretted her actions after she caused Evan to sleep. If the party manages to awaken Evan, Chloe shows her gratitude by giving them 100 gp each and a potion of *invisibility*. But she will not choose to appear until the party has searched the pavilion or unless the party tries to leave without attempting to awaken Evan.

If the party does not wake Evan, Chloe approaches them and pleads for their help. She offers them the *invisibility* potion for helping her. Chloe appears as a young, innocent girl of sixteen. She cries and wrings her hands, telling the party that her lover needs their help. She cannot awaken him and is obviously too distraught to think of a clear solution to her problem.

After the party awakens Evan, Chloe gives them a potion to pour into the lake. This is the antidote for the *sleep* enchantment on the lake. She gives them enough to purify the whole lake, but the entire potion must be poured in. Once the potion is poured in, the area around the lake seems to revitalize and become more pleasant. The birds sing, and the area appears as wild as the rest of the woods.

7. THE WILDWOOD INN

(Map of The Greate Olde Woode, Area 4)

The Old Wilderness Road runs east. Gradually, the path becomes less overgrown. Another old path crosses this one at a clearing and goes roughly north-south. In the clearing stands an inn. The sign, painted with a tree and two resting men underneath, is titled, "The Wildwood Inn."

If the party chooses to pass by the inn, they may set up camp in the area. Check for wandering monsters during the night.

INSIDE WILDWOOD INN

It is cool and quiet inside the inn. The owner, a smiling halfling stands behind a waist-high wooden desk. "Good day, travellers, would you like a drink?—a meal?—a room?—all three?" He patiently awaits an answer.

When the party enters the Wildwood Inn (See Area 4 Map), they meet the proprietor, Bolo Softsole (Halfling, Thief; Lvl 2; AC 7; MV 9"; HD 1; hp 5; #AT 1; Dmg 1-6 [sword]; SA +3 with bow or sling; SD Save at 4 levels higher). Bolo is a cheerful sort, but has a rakish look. He wears a patch over his left eye.

Bolo is a retired thief who made enough during his life to buy this remote inn. He does a good business here, but worries that lawmen will someday come and take him away to jail for his previous exploits. He has turned honest, and would not think of stealing from or cheating a guest.

Rooms cost 1 gp a night. The party may occupy any number of rooms that are available (rooms 4, 5, and 6 are available). An excellent meal costs 5 sp and ale is 2 sp per large pitcher (serves five). The party may stop now for dinner or settle themselves in their rooms before eating.

In each room, two beds sit across from the door, their headboards against the outer walls. Between the beds is a shuttered window. Bolo gives them a key from his large ring to lock their doors. In each room, a small chest rests at the foot of the bed. Each has a lock with a key in it for the customers to use.

When the party eats dinner, they hear certain farmers and travellers swapping tales. They hear two true tales for every falsehood told. Each hour the party sits in the tavern portion of the inn, they hear two of the following stories:

- 6-7 p.m.
1. Goblins/orcs are raiding to the west of the Dragonteeth Mountains as snows have blocked the mountain passes until spring.
 2. Gypsies have been coming into this area from the southern portion of the land; it is said that they curse people who do not give them some silver.
- 7-8 p.m.
3. The Elfin City of Auron, the city of gold, has been sighted to the north by foresters. (False.)
 4. Quiet Lake is a sad place. There is a mysterious woman who is heard crying there. She has never been seen.
- 8-9 p.m.
5. There is a tunnel that goes under the Dragonteeth Mountains. It is old, but still usable.
 6. A dragon lives high in the peaks of the Dragonteeth Mountains and stops travellers from passing through. (False.)
- 9-10 p.m.
7. Giant Wolves have been seen near the Wild River.
 8. The Druids have a forest hideaway to the east of the Wild River.

8. ROBBED

The tavern closes at 10 p.m. Bolo sends all the customers off to their rooms. The lights go out, and the tavern becomes still.

An attempt to rob the party will occur during the night whether any of the party is on watch or not. Any party member on watch has to save vs. Sleep directed at him. If he is successful, the spell will be cast on each party member coming on watch until one is successfully put to sleep. At that time, four wererats (AC 6; MV 12"; HD 3+1; hp 16 each; #AT 1; Dmg 1-8 [sword]; SA Surprise on 1-4; SD Hit only by silver or +1 or better magic weapons) enter the room and rob the party.

The party members should each roll 1d6. Anyone rolling a 1 awakens, and knows he is being robbed. He may pretend he is asleep or call for help. If he calls out, the wererats flee through a secret door located directly across from the hall door. This door stays hidden unless the party sees the rats exit. They may try to locate the door on a normal search.

When the party finds the door, they may wish to pursue the wererats. They may check for the door several times if they wish. If they do not find the door or if none of the party awakens while the wererats are robbing them, they find large rat-like tracks on the floor. Bolo will realize they belong to the wererats staying at the inn.

The wererats are armed with swords. A clever gang, they have been staying at the inn off and on for three months. They rent room #8, and use that as their base of operations. They have disguised their activities so well Bolo hasn't discovered the connection between when they stay and when the robberies occur. The wererats always seem to have plenty of money to pay for their lodging, however.

THE WERERATS

Several furry figures stand upright, light reflecting from their swordblades.

The wererats have secret doors in both the south and east walls of their room. Their treasure trove lies in here, including any treasure stolen from the party. The wererats attack anyone entering their room. They seek to hold the PCs at the door while one wererat takes the money and runs. If the one with the money successfully escapes, the others attempt to break off combat and follow him. On a 1 (1d10), they elude the PCs. If the PCs search, they will find the wererats in a small clearing the next morning.

The wererats' treasure consists of 2,500 gp, 1,000 sp, 9 silver armbands (100 sp each), a potion of *healing* (2 doses), and the PC's possessions.

If the party recovers the treasure from the wererats, Bolo will wish to return it to its rightful owners. Bolo offers the party a 25% finder's reward on behalf of those who were robbed, and sees that the parties to whom the goods belong are notified so they can arrange for transport of the goods. Bolo allows the party to take the potion of *healing* if they wish.

DIRECTIONS FROM BOLO

Bolo says, "Follow Old Wilderness Road. It will lead you safely to the Dragonteeth Mountains and the old Dwarf Cave. Through the cave lies the path to the Wild River. Once beyond Wild River, the Druids' oracle, The Golden Boughs, lies nearby. Be careful, for the country there grows wilder each year, and vermin of all sorts prey on unwary travellers."

Of course, if the party does not tell Bolo where they are going, he will not provide any information.

9. THE HORNS OF THE DRAGON (Map of The Greater Olde Woode, Area 5)

The forest is green and splashed with sunlight. Farther east, tall mountains seem to rise to the sky. These are the Dragonteeth Mountains. The trail goes straight toward the mountains, and then slightly to the southeast. The trees grow less thickly here. The trail appears to lead toward the mountains, and up into them. A wind, hinting at a change in the weather, begins to blow.

Ahead, two spires of naked gray rock jut upward, looming high above the mountains. From here, they seem almost impassable. Nearing them, the chance for a trail upward does not appear to improve until the base of the mountains. A trail skirts the bottom of the spires and seems to run between them.

If the party follows the trail, they find what appears to be a big cave. Standing in the entrance, they feel a breeze. It originates on the far side of the Dragonteeth Mountains. The tunnel looks much used, since the rock has been worn down in places. If the party looks for footprints, they find two types:

1. Footprints of beasts of burden and their drovers going in and out of the tunnel (human).
2. Footprints belonging to orcs going out of the cave. These are several days old.

10. THE TUNNEL UNDER THE DRAGONTEETH MOUNTAINS

The tunnel leads into the heart of the mountain. Light from the outside world becomes dim, goes gray and finally disappears.

The breeze grows stronger, and the light of the torches and lanterns flickers. Along the walls, niches carved by unknown hands hold burnt torch stubs. The floor of the tunnel runs straight and flat. A slight layer of dust lies over the smooth surface of the floor.

CAVERN 1

About 5,500 feet into the tunnel another tunnel leads sharply off to the south. The wind blows steadily from the east.

If the party examines this dusty tunnel (#1 on Area 5 Map), they find a large, empty cavern roughly 1500' x 1500' and 20' high. It is empty, and there are no signs of life, although on the floor lies a skeleton (dismembered) of a deer. The party sees nothing on the way into this tunnel. On the way out, however, they notice that the walls of the tunnel are supported by rafters that look exceptionally old and weak. The rafters will begin to groan and creak as the party passes. After the party leaves the side-tunnel area, the timbers give a final groan and collapse, showering the main tunnel with dust and small bits of flying rock. Thereafter, cavern #1 will be sealed off.

CAVERN 2

The direction of the main tunnel changes slightly to the south-southeast. Even though the direction of the tunnel has changed, fresh air still blows from the exit, due east. About 4,500' east of the entrance to tunnel #1, the main tunnel turns due south for 1500' before it bends south-southwest for another 1500'. It ends in a cavern 3000' long, 800' wide, and 20' high.

Small tools lie near six mounds of earth which seem to have fallen from the ceiling. Something protrudes from under one of the piles of earth.

This cavern is crumbling and in poor condition (#2 on Area 5 Map). Like the first cavern, it threatens to collapse if its supporting timbers are treated roughly. If the party investigates, they find a small mattock and sledge-hammer, suggesting that someone smaller than a human used them. If any party member rolls his wisdom or less, he recognizes these as dwarven tools.

Under one pile of rubble a boot sticks out. Under the boot, a skeletal foot is attached to a leg, and so forth, until the entire skeleton of a dwarf in mail, buried in a minor cave-in, is uncovered. The dwarf has 25 gp in his purse. If anything is taken from his skeleton, or any of the five dwarf skeletons under the other piles, all six animate and attack. These dwarven skeletons (AC 7; MV 12"; HD 1; hp 5 each; #AT 1; Dmg 1-6 [war hammer or mace], SA None; SD Suffer only 1/2 damage from sharp or edged weapons, and full damage from blunt weapons) fight until they are totally destroyed. None of their armor fits man-sized or larger creatures, and none of their weapons are magical. Each skeleton possesses 25 gp in a pouch.

If the party chooses, they may attempt to bring down the roof on the skeletons by pulling away supporting rafters and beams. This prevents the skeletons from getting at the party; however, the party will not be able to get any of the treasure the dwarves have in the pouches at their waists. The party will become trapped on a 1 on 1d20 and must spend 6 hours digging themselves out.

The Trail Splits

The tunnel goes north-northeast for about 2500' until a noticeable split occurs in the trail. Branches lead northwest, northeast, and south-southeast. Of the three branches, only the one going north-northeast has a breeze.

CAVERN 3

The tunnel to the northwest leads to an empty cavern. There is evidence of mining in the past; chipped rocks and other debris cover the floor. High pitched laughter rings out from behind a large boulder and out steps a tiny, hunched figure dressed in rags and shredded chainmail.

"I see you found your way in past the orcs—tee-hee-hee. You must be very, very careful or they catches you and does bad, bad things to you. I know, I have seen them. They can't catch me—tee-hee-hee. They try and they try, but I escape and escape. Hee-hee, they can't catch me!"

Thisvynn Talus (Dwarf, Fighter; Lvl 3; AC 7; ST 17; I 14; W 15; D 12; Con 19; Ch 10; HD 3; hp 20) is crazy. Living alone for countless years in the played-out mines and collapsed tunnels has taken its toll on him. He has lived in fear of the orcs for the last twenty-five years, and has waged a guerilla war on them. On a 1-3 (1d6) he is insane, stringing answers together with fact and whimsy; on 4-6, he is perfectly sane and coherent. This is rolled each turn.

The dwarf knows the secret of what is hidden in the dwarven forges. The entrance to the forge area is behind the large rock.

The party may search the mine. Any party member who rolls a 1 on 1d6 finds a small piece of worthless gemstone. No other gems are found.

To Cavern 3A

"I know why you're here," Thisvynn says. He looks around craftily, "The orcs have searched for ages for my secret. They can't have it—tee-hee-hee. No one can have it unless I want them to, and I don't want the orcs to have it." He puts his finger to his lips, "Shhh! They are listening. I can tell." He turns and motions toward the rock.

Behind the rock is a narrow ribbon of land that seems to waver in the torchlight. "Walk carefully. Stay behind me. It is a long way down." He tosses a pebble over the side. It clatters and clicks on the way down, but does not hit bottom quickly.

This narrow ribbon of land extends across a great chasm. No bottom is in sight. Characters must roll their dexterity or less or lose their balance. A character losing his balance falls to the edge. He must make his second roll or go over the edge. The chasm is almost 200' deep. If the PCs are roped together, add 3 to the PCs' dexterity rolls. If any PC still fails both dexterity rolls, the rope will break and he falls into the chasm.



CAVERN 3A

Thisvynn holds the torch high. Light glints off rusted metal-working equipment and partially finished weapons. "This is the famed lost dwarven forge of the Dragonteeth Mountains." He shakes his head sadly, "Gone, all gone."

No weapon the party finds is of any value. If the party investigates carefully, they find an anvil sitting on a wooden base. The base will yield a hollow sound if tapped. Concealed inside the base, the party finds *magical bracers +1* (brought here to have gold leaf put on them by dwarven craftsmen), a man-sized suit of chainmail, and a *sword +1*. Thisvynn knows what these items are, but he must be sane to tell the party the truth. Otherwise, he will tell them that they are *bracers of fumbling*, *chainmail +3*, and a *cursed sword (SS)e(SX)+2*. He believes this to be true when he is insane (See #3A on Area 5 Map).

The Osquip Attack

A stone clatters at the side of the cave. There stands a peculiar creature with six legs, about the size of a small dog, yellow in color, and possessing spade-like teeth which project from its exposed bony jaw.

For each person in the cavern, one osquip (AC 7; MV 12^{1/2}); HD 3+1; hp 19 each; #AT 1; Dmg 2-12 [bite]; SA/SD None) will appear. They slink forward, uncertain, making small squealing sounds to themselves. The party will be able to attack the osquips first. For every round the melee continues, one additional osquip comes from their hidden tunnel complex high in the rock-face above the forge.

The attack by the osquips makes Thisvynn go totally insane. He begins screaming and cannot be reasoned with. His strength becomes 18(75).

Thisvynn's Attack

Thisvynn runs around, hitting at the osquips with a wooden club. One osquip takes a bite out of him, leaving his arm hanging and useless. He screams wildly, "Run, it's the end of the dwarven forge all over." He then runs to a large bracing timber and tugs at it. "Run," he yells, "or you are doomed!" Rocks and earth threaten to fall from above.

The party may run or attempt to stay and fight. The osquips will not follow them across the bridge of land. Party members crossing back must again roll their dexterity or less or stumble. If they fail a second time, they fall into the chasm. Add 3 to the PCs' dexterity rolls if they are still roped together. As soon as they make it to the other side of the bridge, Thisvynn tugs the support beam free.

The Osquips' Demise

"I've got you orcs now," Thisvynn chortles with insane glee. "Tonight I will feast in Valhalla while you cringe in Queen Hel's dominion!" The ceiling shudders. Osquips pour out of the facing rock and bear him to the ground. The ceiling collapses, taking the land bridge with it, and sealing that cavern.

The party may wish to stay, but nothing more can be found in this area.

CAVERN 4

The tunnel to the south-southwest also has poor rafters and bracing. Echoes and other noises stop an instant after all movement stops.

The echoes are caused by the peculiar construction of the tunnel which is a maze, honeycombed with passages. Even the sound of the smallest stone falling reverberates and creates eerie sound effects. No treasure lies in this tunnel.

CAVERN 5

The tunnel leads northeast about 3500' until a tunnel leads due south from it. This tunnel runs 500' and ends in a wall of earth.

This portion of the tunnel has collapsed. Once, a cavern lay beyond this, but caved in long ago. A few jagged timbers jut out from the wall of earth. If the party looks, they will find a sign in old Dwarf which reads "Danger—Bad Timber—No Admittance."

CAVERN 6

The main tunnel goes northeast for 2,000' and turns due east for 2,000'. A side tunnel extends to the southeast and proceeds for 1500' before opening into a cavern.

The floor of the cavern is covered with murky water.

The cavern, 1500' by 2000' across, is filled with 40' of water (#6 on Area 5 Map). A ledge lies on the far side of the cavern, but no exit.

Anyone attempting to swim in the water or cross it attracts the attention of two giant eels (AC 6; MV 9"; HD 5; hp 25 each; #AT 1; Dmg 3-18 [bite]; SA/SD None). These white, sightless eels are attracted to the vibrations of things disturbing their pool. If killed and cut open, their stomachs will yield their treasure: a *ring of fire protection* and 200 gp in the first, and a *magic wand* with one remaining fireball in the second.

CAVERN 7

The wind blows steadily, perhaps just a little stronger than it blew before. About 2,000' east of the last tunnel entrance, a tunnel leads north. This tunnel goes for 1500' and ends abruptly in a tumbled wall of earth and stone.

This caved-in cavern was once similar to cavern #1, but time has taken its toll. The rafters gave way, spilling tons of earth and rubble into the cavern. Rotted timbers stick out from the pile of debris and stone.

CAVERN 8

The tunnel winds east for 2,000' and takes a turn toward the southeast. A tunnel leading to the southwest for 1200' opens into a cavern. The sound of echoing footsteps comes from this tunnel.

A die roll of 1 on 1d6 reveals orc footprints in the dust. The tunnel leads to the hide-out and treasure room of the orcs who have been marauding to the west side of the Dragon-teeth Mountains. The echoing footfalls were the footsteps of the orc sentry who was on guard duty at the mouth of the tunnel leading to cavern 8. He heard the party approaching, and fled into the cavern to warn the other orc warriors.

The Orc Cave

The tunnel leads to the southwest and opens into a cavern that is 1500' long, 750' wide, and 20' high. Standing across this opening are 21 figures. One in the lead wears leather armor and carries a spear. Behind him are three others in chain mail, and a band of about 17 more. They are man-sized, pig-snouted humanoids who converse in grunts and slurred sounds.

The party has come upon the orcs. They are led by the guard who first heard the party coming. Behind him is the leader and two assistant leaders. Following them are 17 fighters armed with swords (12), spears (3), and axes (2).

The leader and his two main followers (AC 6; MV 9"; HD 1; hp 8 each; #AT 1; Dmg 1-8 [sword]; SA/SD None) carry swords and shields. The guard and the followers (AC 6; MV 9"; HD 1; hp 6 each; #AT 1; Dmg 1-8 [sword]; SA/SD None) carry swords.

These orcs belong to the Bloody Hand band, and have that emblem on their shields. They follow their leaders and fight until they are wiped out. Equal numbers of orcs assail each member of the party. The orcs fight to subdue the party so they can enslave them. The orcs will then disarm the party and take them into the back of the cavern. The orcs bind the party members securely, setting two guards over them.

If the party overcomes the orcs, they may collect the orcs' treasure in the back of the cavern. The treasure is listed in the next encounter. Turn to section 16B., East of the Dragon-teeth Mountains, to continue.

Captured

At the back of the orc's large cavern, 50' away, are five wooden chests. A guard stands watch. He leans on his spear, looking ferocious.

"You weren't nearly as clever as you thought, were you? Tried to sneak by us, but it didn't work, did it? You look fit enough—I suppose you'll work for a while before you become useless. Know what happens when you get tired and useless?" He grins and draws a rough thumb across his throat, making a slitting sound.

The chests hold the orcs' wealth. Three chests hold 250 gp, 500 sp, and 2500 cp respectively. A fourth chest contains 50 uncut gems (10-100 gp each) and the fifth contains the following magical items:

- 1 potion of *giant control*
- 1 potion of *plant control*
- 1 potion of *speed*
- 1 scroll of *protection from undead*
- 1 scroll of *protection from were-tigers*



Another orc warns, "If any of you try to escape, the rest will be taken back to the cavern and tortured to death." The orc in charge seems to like that idea. He is armed with a spear and a broadsword. Other orcs are armed only with broadswords.

Two orcs watch the party while the others rest and drink wine or eat. One guard watches the wood cutter, and another watches those gathering fallen branches. The four orcs sit between the two groups, roughly 150' from either. The guards are more interested in watching their friends than a group of prisoners.

Two orcs will help each guard if the party attacks. If the party manages to overpower its orc guards by using the fire axe and large branches as clubs, they can return to the cavern and pillage it. If they choose to do so, they will have to sneak up on the guard at the mouth of the orc cavern. If the party cannot overpower the orc guards, they are able to escape into the woods. They may then return to surprise the injured orcs and finish them off.

RETURN TO THE ORC CAVERN

From the cavern comes the sound of shuffling feet. An orc on guard duty stands facing the west.

During the day, from 1-6 guards stand outside the orc cavern. The guards always wear leather armor and carry spears. They expect trouble from the west so the party has a chance (1-2 on 1d6) of sneaking up on them.

Although the fight may cause a clamor, there is no one the orcs on duty can go to for immediate help. Once the orcs are wiped out, the party can plunder the cave at leisure. If the party is fighting, and only one orc remains, he attempts to run for help. If the party follows him, they catch him before he reaches help. If they do not follow him, he ultimately finds his way to the western side of the mountains and tells the raiding party what transpired.

The orcs out pillaging the west side of the Dragonteeth Mountains will seek revenge and lie in wait for the party at this pass through the Dragonteeth Mountains.

Put to Work

The orcs offer no supper that evening. The next day, breakfast consists of a stale hunk of bread and a cup of water. A guard of 6 orcs enter the cavern. "You are to cut firewood and gather brush for fires today," one scowls. "Come with us."

The party still has their armor. Unless weapons were concealed well on any of the party (1-2 on 1d6), they were found and confiscated by the orcs. The party has no treasure or magical items (unless the magical items were worn on the person and passed over by the orcs who disarmed them, a 1 on 1d6.)

11. THE EASTERN EXIT OF THE DRAGONTEETH TUNNEL (Map of The Great Olde Woode, Area 6)

The eastern exit is 5,500' down the tunnel. The orc guards are spread out with three in front and three behind. Once outside, an orc says, "One of you go cut firewood," and holds out an old axe. "The rest of you are to gather brush and fallen branches."

East of the Dragontooth Mountains

1. THE DRYAD GROVE

(Map of The Greate Olde Woode, Area 7)

The terrain is much the same as the west side of the Dragontooth Mountains. A slope rolls gently down to the woods and, in the distance, a river cuts through the forest. On the eastern side of the river, a spire pierces the green expanse of the forest. The path leads downhill to the southeast, yet in the general direction of the river and the spire.

As the party follows the trail to the river, the sound of someone cutting wood becomes noticeably loud. The chop of axes and the scratching of saws on wood becomes interspersed with loud, rude laughter, and rough, uncouth voices.

If the party listens carefully, they realize that the voices are speaking Orc.

THE ORCS

The path leads by a small knoll covered with trees. In the center of the trees stands a tall, ancient tree whose branches seem to spread protectively over the smaller trees and bushes in this area. Four figures are gathered in the grove. Two are sitting and drinking from a wineskin while two others hew away at the mighty oak with axes. After a while, the two with axes rest and the two who were sitting begin attacking the tree with a saw. These four are applying themselves to this particular task with vigor. They are unaware anyone watches.

The four orcs (AC 6; MV 9"; HD 1; hp 6 each; #AT 1; Dmg 1-6 [sword]; SA None; SD None) are clad in leather. The orcs are not here to cut wood, but to plunder the dwelling of a dryad. She lives in the ancient oak tree they are attempting to cut down. The dryad (AC 9; MV 12"; HD 2; hp 11; #AT 1; Dmg 1-6 [dagger]; SA Charm; SD Dimension Door and Charm) does not wish to see her home or the grove of trees damaged in any way.

The party will have surprise if they attack the orcs. Other than the two axes, the orcs are only armed with swords.

If the party attempts to slip by the group of orcs, Perciss, a pretty damsel, appears to them.

THE DRYAD

A young girl, blond, about sixteen, and clad in a robe of pastel green and yellow appears. She wears a laurel wreath about her head. Her big, brown eyes are on the verge of tears. "Will you help me? Those vile creatures are trying to destroy my tree. Please stop them."

If her first appeal for help does not work, she appeals again, this time with the aid of a *charm* spell on the member of the group she feels will be most susceptible.

BATTLING THE ORCS

The orcs look up and draw their swords. One, smaller than the rest, but with a slight air of authority grunts something and they move to attack.

The smaller orc is their leader, but is in no way superior to the rest of the party. The orcs fight until killed, or until they kill all of the adventurers.

If the orcs are killed, the party discovers that each orc carries 10 gp, 20 sp, and that most of the weapons the orcs use are in no way extraordinary. If the party carefully checks the sword used by the small orc, they see a faint tracing of runes on its blade. If an elf or dwarf picks up the blade, they recognize it as a dwarven blade which was forged for the elves. In orc hands it was unknown, but it is a *sword +1*.

A GIFT FROM PERCISS

The dryad, Perciss, is grateful that her home has been spared. "Please wait a moment," she asks. "I have a gift for you." She disappears inside her tree, and returns a minute later. She holds a small, blue glass bottle containing a liquid. "It will help you fly," she explains.

"You are welcome to spend the night in my oak. Inside, no harm can befall you. Neither orcs nor dire wolves can enter."

The liquid is a potion of *levitation*. One dose remains in the bottle. If the party explains their journey, Perciss tells them they are on the correct path to Golden Boughs. She warns them to be wary, lest they fall victim to the cruel dangers on the east side of the Wild River. She says it might be wiser to seek the lower crossing on their return journey, as the orcs have friends who might waylay them on the trip home.

If the party desires to move on, she warns them about the large wolves (dire wolves) which have been seen lately in these woods. She mentions that the temple of the Druids lies several days' journey to the east.

2. THE WILD RIVER

(Map of The Greate Olde Woode, Area 8)

The path goes down the hill, ending abruptly at the river bank. The river runs full force, thrashing its way south over rocks and shallows. In parts, the river does not look too deep to ford; in other portions, no bottom can be seen. There is a sturdy-looking rope bridge across the river.

The rope bridge is shaped like a "V" with one rope for the party to walk on, and two ropes (one to either side) for hand holds.

Wild River cannot be forded here, but it may appear that way to the characters. If someone fell in, he could swim, but there are many places that are well over a man's head. The rope bridge is the only way across at this point. Downstream 9-11 miles is a ford which the party can wade across, but there is no other in this area.

WORG FOOTPRINTS

Something mars the dusty area around the bridge. A closer inspection reveals footprints similar to a dog's, only much larger.

The only creatures able to cross the river without danger are the great worgs (dire wolves) which the dryad mentioned. A careful inspection of the riverbank on this side reveals footprints of the large wolves.



When the members of the party cross the bridge, they must do so only two at a time, so that one person is starting when the other reaches the middle, and so forth until all members of the party have crossed. Each member attempting to cross the bridge must roll his dexterity or less. If he fails, he must roll again successfully or fall into the waters of Wild River.

Those falling into Wild River do not drown. The river tears away a random article. Roll 1d4 to determine what is lost.

1. A sword or main weapon of a character is lost.
2. A dagger or secondary weapon is lost.
3. A magical item is lost, or 200 gp if the party member has none.
4. Half the person's treasure, to include jewelry and gems but not magic, is swept away.

The water sweeps the party member toward some rocks near the eastern shore of the river. He must once again roll his dexterity or less or receive 1-2 hp of damage from being battered on the rocks.

If any party member falls into the water, he will avoid the damage caused by the rocks if another party member throws him a rope.

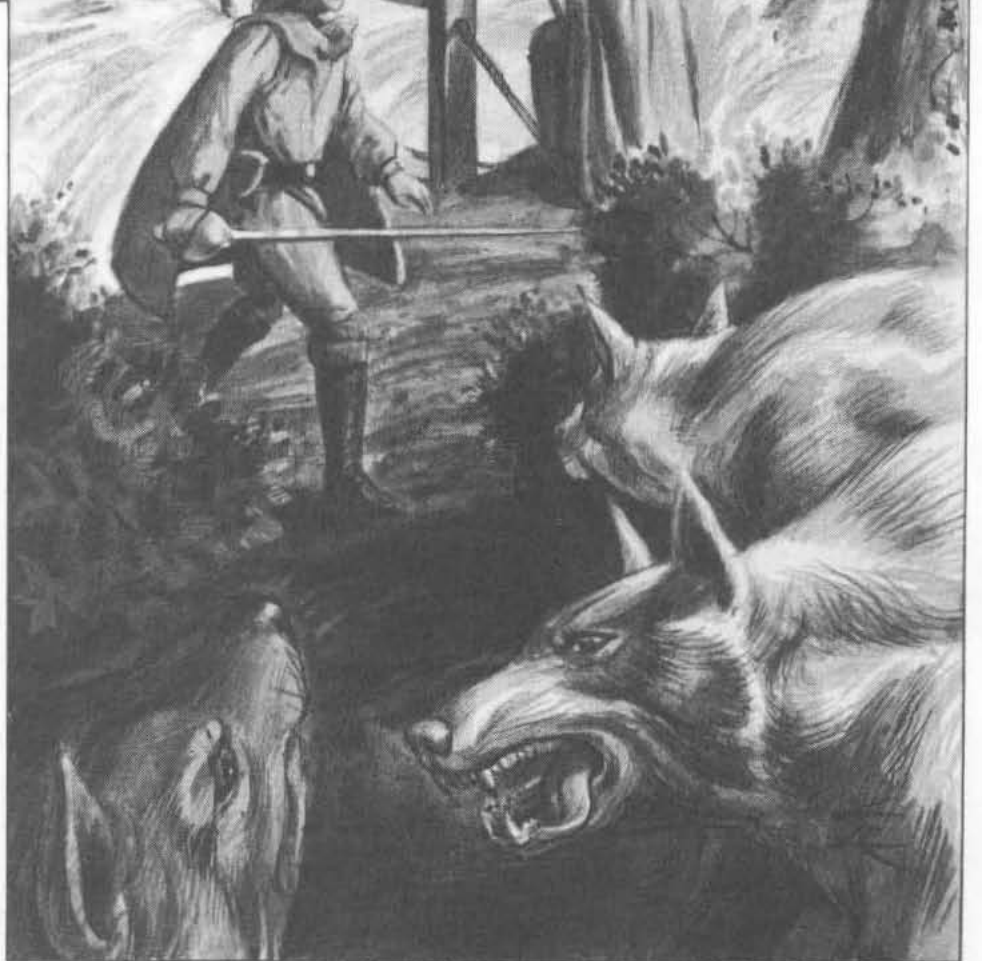

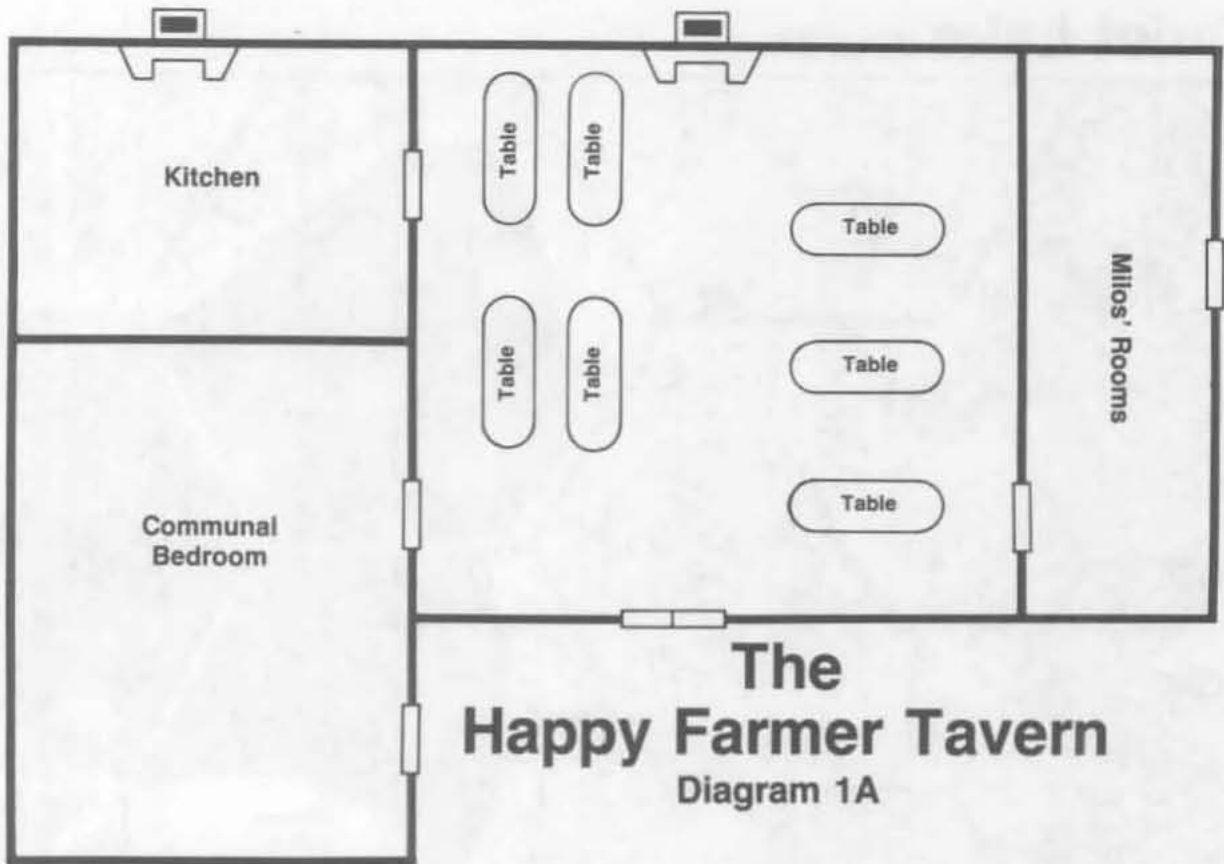

The Brigands' Camp Area 2B

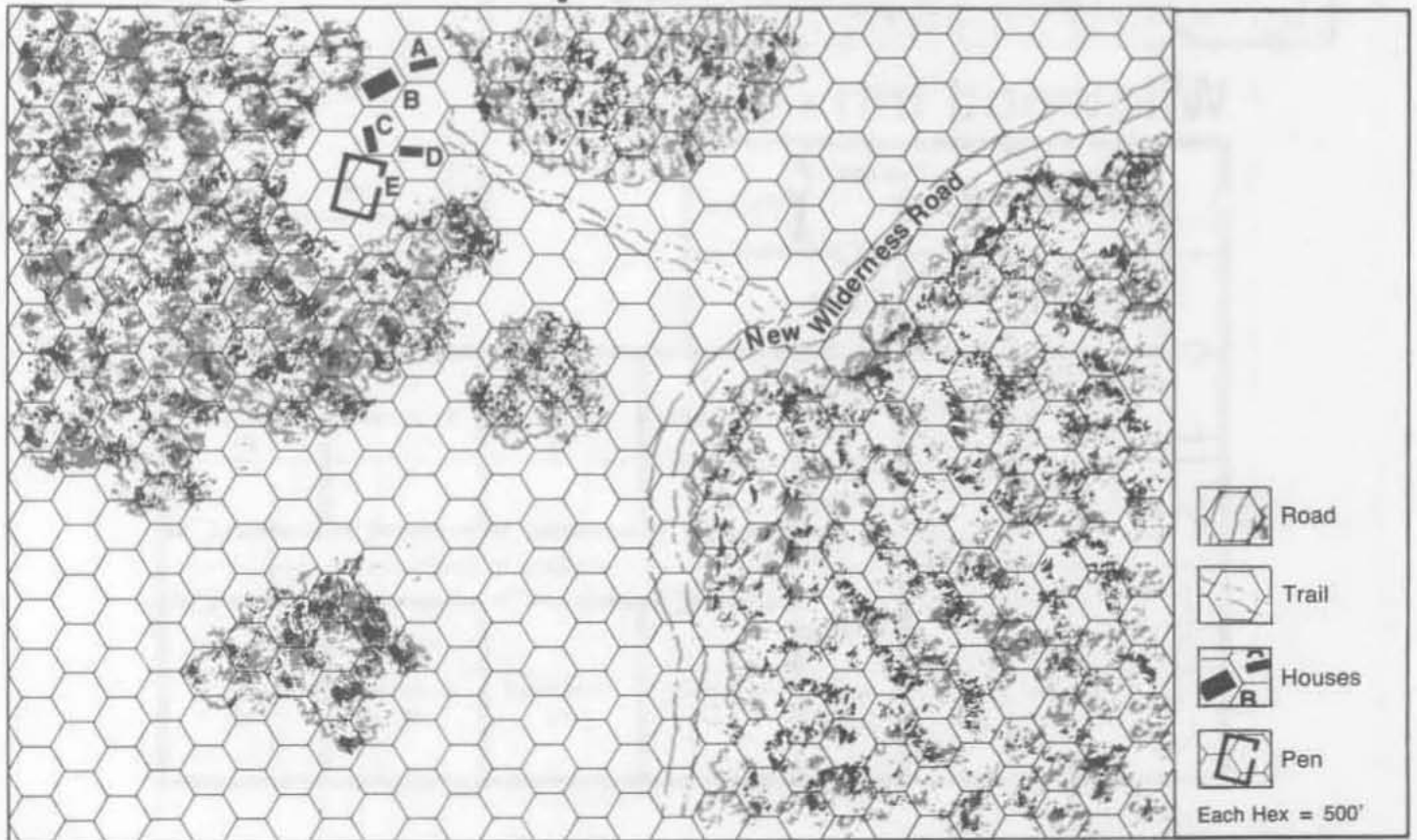

Quiet Lake Area 3A

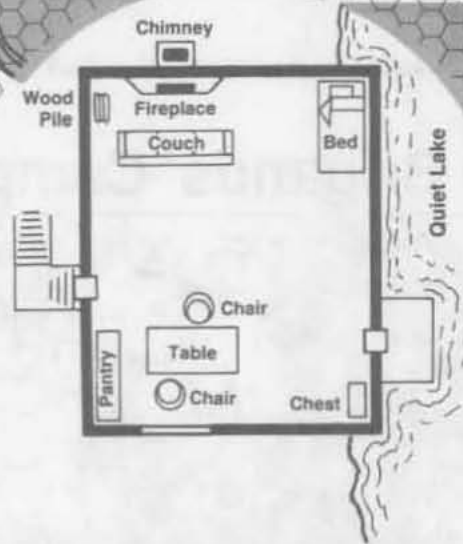
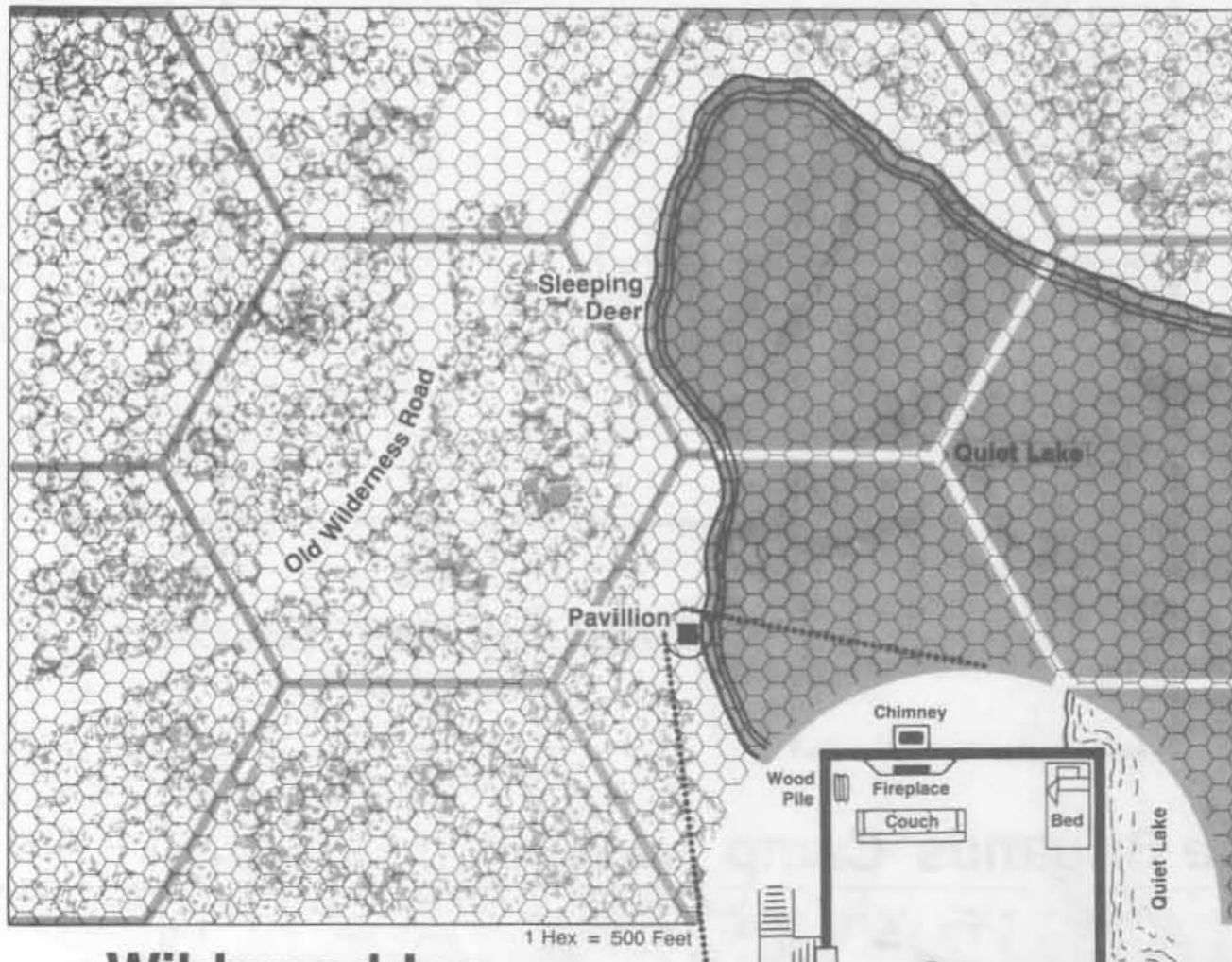

Wildwood Inn Area 4

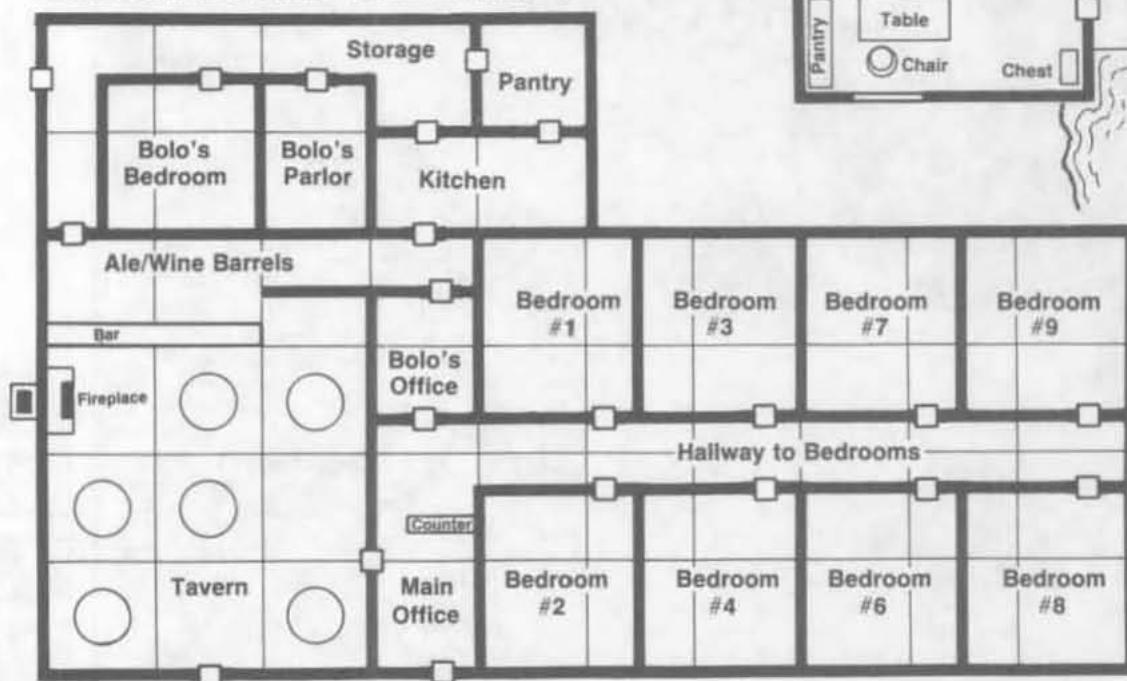

The Ruins of Castle Karn Area 9

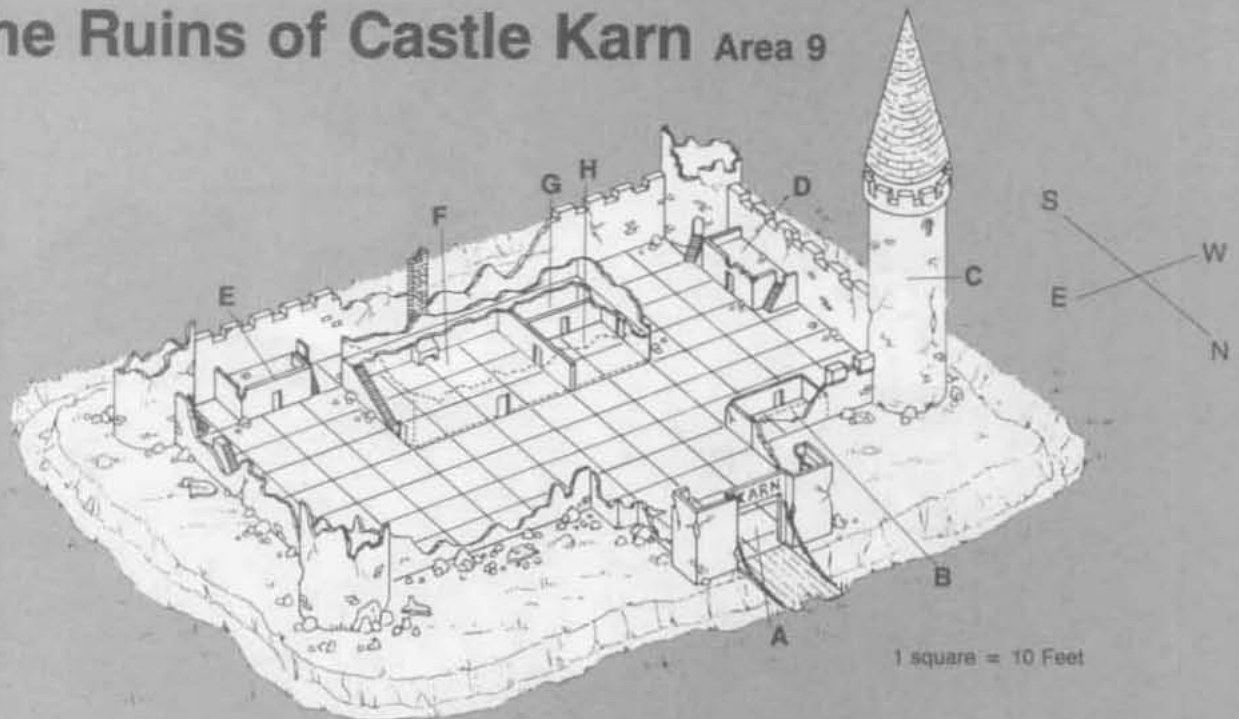

The Druid's Oracular Tree Area 10

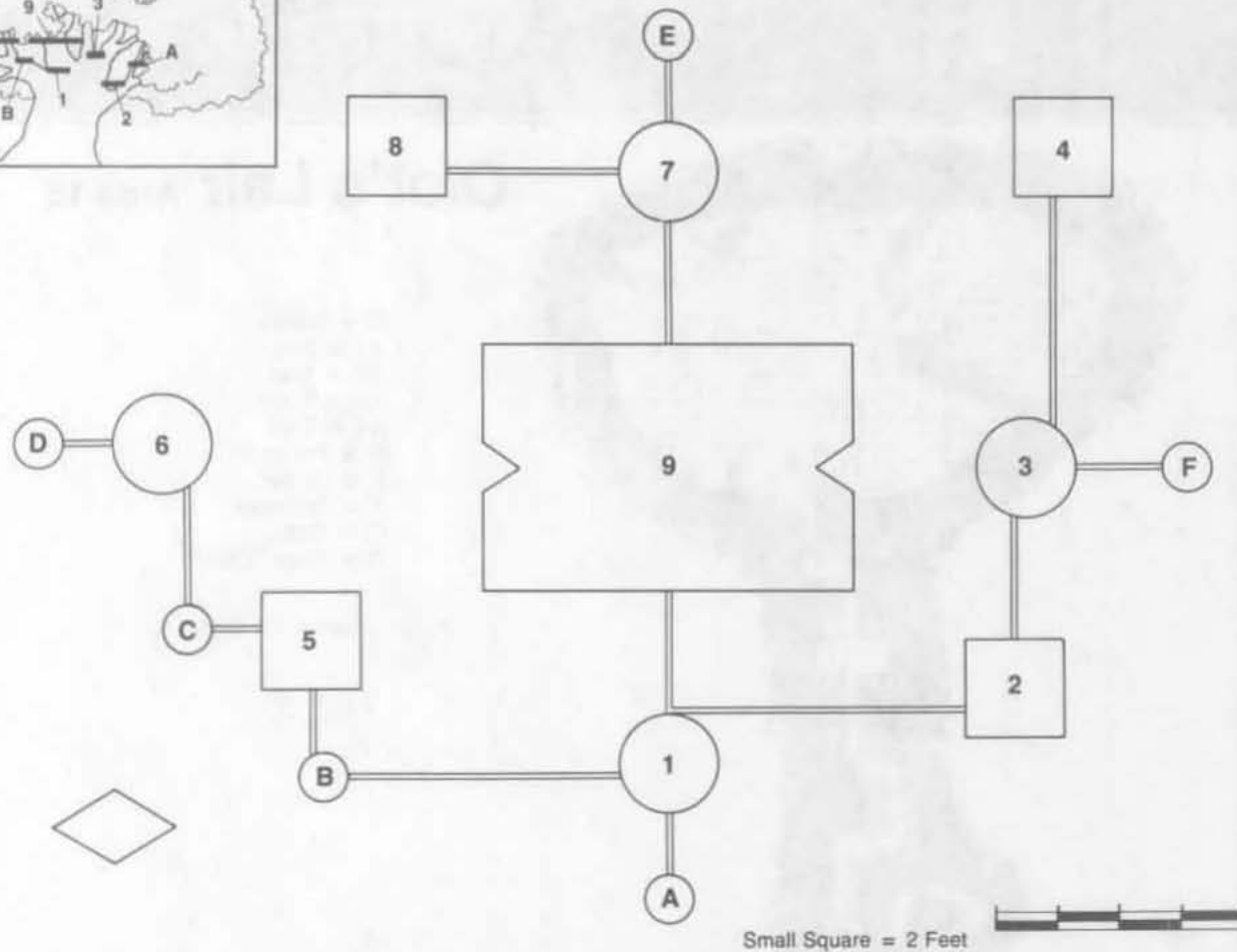
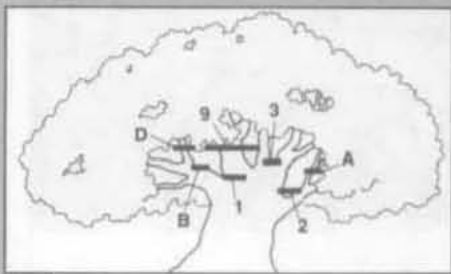

The Yeti's Lair Area 13

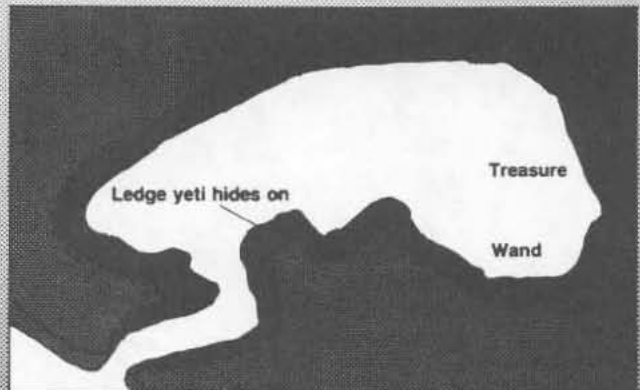

Inset of Lair

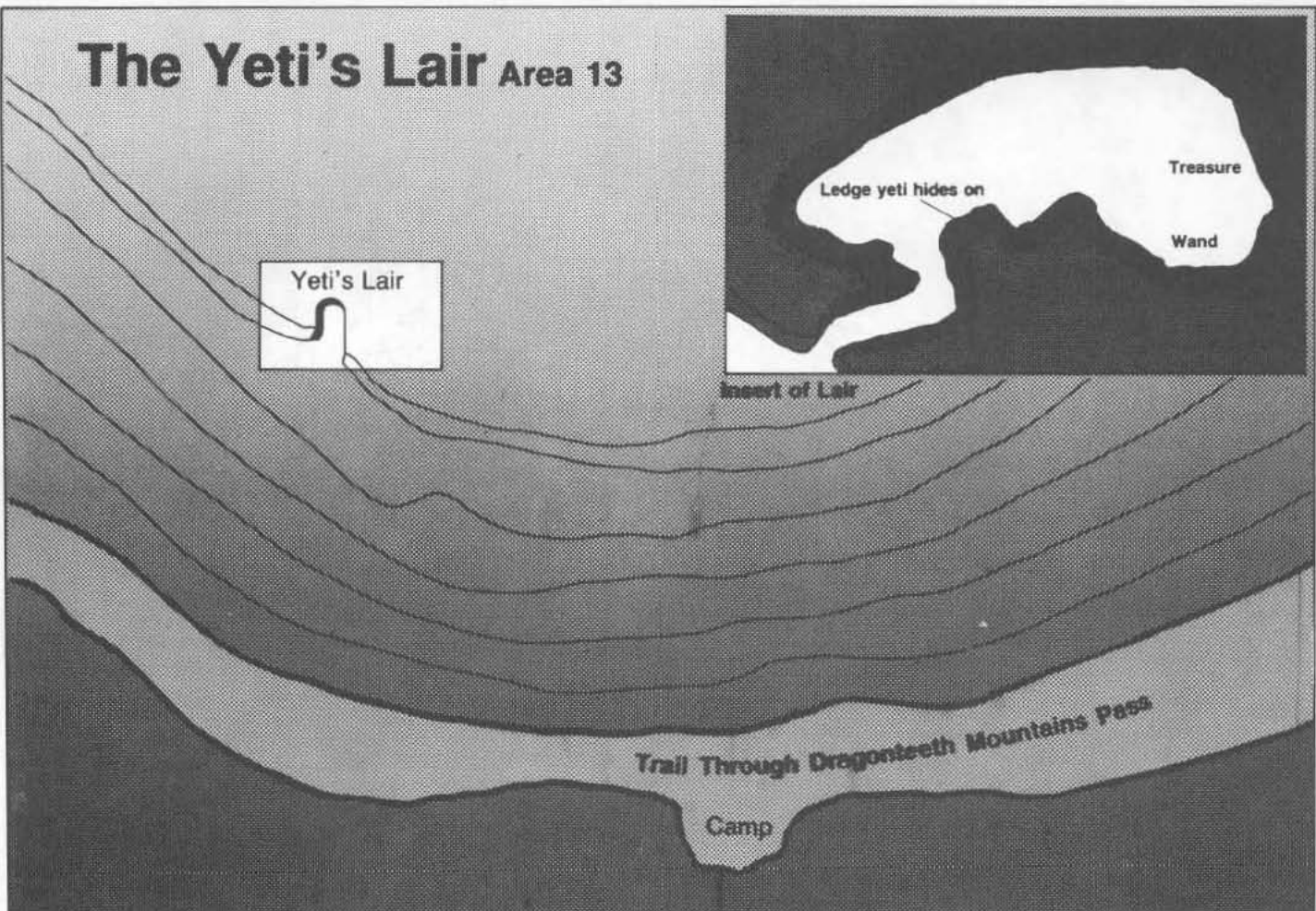

Trail Through Dragonteeth Mountains Pass

Camp

Olot's Lair Area 15

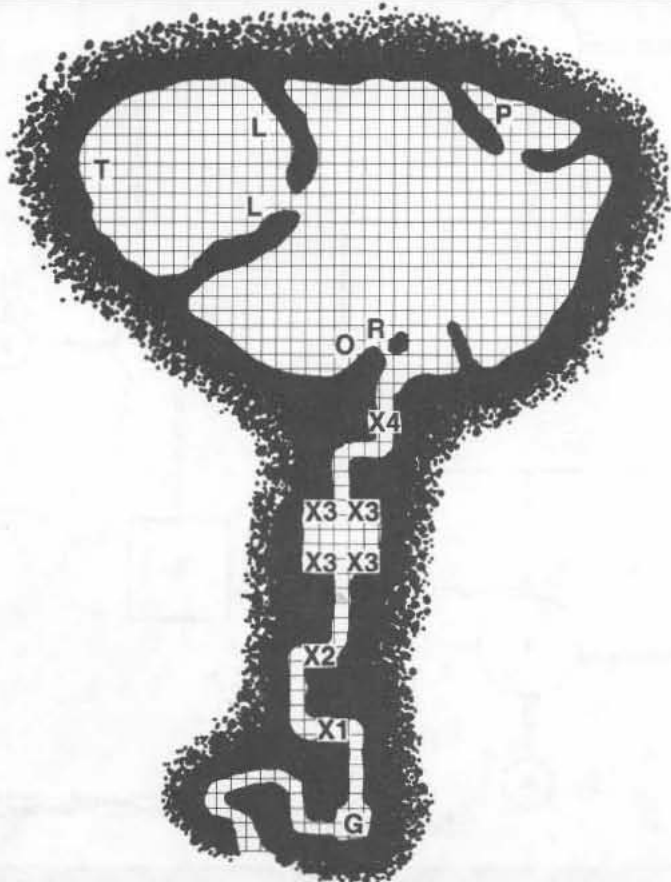

- G = Golem
- X1 = Trap
- X2 = Trap
- X3 = Traps
- X4 = Trap
- P = Pegasus
- L = Larder
- T = Treasure
- O = Olot
- R = Rock "Door"

1 Square = 5 Feet

3. THE WEST BANK OF WILD RIVER (Map of The Greate Olde Woode, Area 8)

Several snarling wolves, about the size of small bears, rush out of the forest.

From 2-4 worgs (AC 6; MV 18"; HD 3+3; hp 18 each; #AT 1; Dmg 2-8 [bite]; SA/SD None) charge the party as soon as they reach the shore. These animals will surprise the party on a roll of 1 on 1d10. Otherwise, they bay and give themselves away.

If the party defeats the worgs and searches the area, they will find several square yards of matted brush where the dire wolves rested. The area is littered with refuse such as bones, feathers, and furballs. If the PCs search carefully, they will find two bracelets and a diamond ring inside a furball. The bracelets are worth 300 gp and 50 gp, and the diamond ring is worth 900 gp.

4. THE RUINS OF CASTLE KARN (Map of the Greate Olde Woode, Area 9)

A tapered spire of gray stone rises from the heart of the woods ahead. The path runs northeast, toward the spire. The forest grows thick and heavy on both sides of the narrow trail, the tree branches far overhead dissipating the sunlight long before it reaches the ground.

About six miles into the forest, vegetation becomes sparse, and the trees do not tower nearly so high. Nothing stirs, as if all living creatures have sighted an ominous intruder.

As the party travels along the Old Wilderness Road, they will not find the entrance to the Old North Road.

INVESTIGATING CASTLE KARN

Ahead lies a clearing filled with ruins. Rising out of the ruins is a single tower. A few roof tiles are missing, but of all four towers to this castle, only this one has survived. The other four lie crumbled in useless heaps of stone. Nothing stirs within the compound, which is covered with weeds and rubble. One pitted and scarred story remains of the main keep. The east keep wall rises another 60 feet and ends in a jagged edge. Great stone stairs support the eastern wall from the inside, but no longer lead anywhere.

A massive gatehouse, only the front wall intact, faces the road. A drawbridge crosses a moat overgrown with weeds. Over the arch of the drawbridge is a lintel inscribed with the word *KARN* (See Area 9 Map).

Castle Karn now lies in ruins. It once guarded this road against invaders and robbers, but it fell to siege centuries ago and was never rebuilt. It is useless now, except for the main hall where goblins have made their headquarters. The goblins are not in the castle complex now, but are on an expedition to find and enlist worgs as their partners and mounts. They will not return until after the party leaves.

THE CASTLE INTERIOR

The main keep of Castle Karn has one floor intact. The massive oak doors are blackened by fire and time.

Inside the inner ward, one tower, three outbuildings, and the lower floor of the keep still stand. The walls are all 10' thick and 20' high. Piles of rubble in the yard are not easily crossed because of the dangerous footing caused by the debris.

Area A

Massive coils of rusted chain wrap around ancient winches and disappear through two beams in the ceiling. The east and west walls lie mostly in ruin, although the front (north) wall still stands.

This is the gatehouse. The machinery was used to raise and lower the drawbridge. The drawbridge, rusted and settled in place, has not functioned for over a hundred years.

Area B

A stone shed stands against the inside of the castle's north wall. The roof has bark shingles and the wooden door hangs askew.

The shed was used for storage but now contains only dust and a pile of rubble. If the party digs through this rubble, they encounter 5 rot grubs (AC 9; MV 1"; HD 1; hp 4 each; #AT 0; Dmg Nil; SA Will infest person and burrow to heart in 1-3 turns, causing death; application of flame or *cure disease* kills them, SD None). Nothing of value is hidden here.

Area C

This tower's stairs lead to a closed, wooden door facing the inside of the courtyard. The stairs are stone, and 20' high.

This tower room is used by the goblin leader. The door is closed but not locked, and it will open easily. Inside is a round room and stairs leading up to a level with a collapsed floor.

In the room lies a dirty pallet and a small chest. Rotted wooden stairs lead to the collapsed floor above.

The chest is booby-trapped. When anyone tampers with the lock without inserting a key (even though the lock is unlocked), a dagger flies out of the false front of the chest. The dagger is angled slightly upward so that it hits a normal-sized man in the chest. In the chest rests the goblin's dirty laundry.

Should anyone check the filthy pallet, they find a small lump on the underside. If the pallet is slit, five gems worth 100 gp each are found inside. There is nothing else of value in the room.

Area D

This shed is well-insulated, but run-down. The door swings loosely on its leather hinges, and several of the wooden shingles on the roof do not look like they would survive a good windstorm. The room smells as if some large animal has been kept here.

The worgs are quartered in this shed. The door opens with no difficulty. No worgs wait inside. It is dim, and the only light entering filters through the cracks in the shingles or the open doorway. Piles of moldy straw lie about that the worgs use for beds, but there is no treasure. Several brownish-gray hairs are stuck behind a splinter about four feet off the ground on the door jamb.

Area E

This shed stands against the south wall of the inner courtyard. Half the shingles are missing from the roof. The door is in good shape, and is locked with a large hasp and chain.

"Don't hurt us—we have no weapons," call two voices from within.

Goblins keep prisoners in this shed. Inside are two female prisoners, Eva and Fiona (Lvl 0; AC 10; MV 12"; HD 1; hp 4 each; #AT 1; Dmg Nil; SA/SD None). Both were out picking berries near Wild River late yesterday, when the goblins captured them. They have no idea where the goblins are now.

The girls have no treasure, but know the goblins have some because they heard the goblins arguing about it.

Area F

The doors to the old keep are time-scarred and blackened and do not open. The surface of the door appears to be disintegrating, as singed wood can easily be broken off.

The doors are locked, but the lock is old and can be broken. It takes a combined strength of 25 to break it open.

The Goblin Barracks

Leaves and straw used for bedding cover this area. The stairs on the east wall lead to a second floor which has a collapsed roof. A large fireplace dominates the center of the back wall.

This is the main barracks area of the goblins. They cook, eat, and sleep here. The fireplace at the rear is used for cooking only. The ashes in the fireplace are cool. There is no treasure here.

Door to the Supply Room

A door in the west wall stands ajar and leads to what appears to be another room.

This doorway leads to area G.

Area G

Large barrels, sacks of flour, and dried meats fill this room. Three skinned deer hang from the roof. Another door on the south wall does not open. Fresh scratches around the keyhole show that a key or something has been used recently.

This is the supply room. Lining the walls are supplies the goblins brought with them or stole.

The door in the south wall leads to area H, the treasure room. It takes a combined strength of 25 to break down.

Area H

Inside are several huge jars of coins. In the northwest corner lies a sack. A small, closed coffer is pushed against the back wall.

THE RATS OF CASTLE KARN

Scampering and scurrying sounds accompany loud squeals. Five gray-brown creatures with shining eyes and long, slender tails appear.

This back room is home to five giant rats (AC 7; MV 12"/6"; HD 1; hp 3 each; #AT 1; Dmg 1-3 [bite]; SA Disease; SD none).

The rats attack anyone who enters. For every wound the rats inflict on a person, that person has a 5% cumulative chance of contracting a disease (DMG p. 13). The rats are trapped with no quick way out (they climb in and out through a small hole in the roof). They fight to the death.

The jars contain 200 gp, 500 sp, and 10,000 cp. In the coffer lies a pearl necklace worth 750 gp. The catch to the lid of the coffer is trapped with a poisoned needle. Anyone opening it must save vs. Poison. The slow-acting poison inflicts 1-4 hp of initial damage, and then 1 hp per day until the victim is cured by any *cure wound* spell or dies.

The jars of coins are too bulky to move. The party may wish to place them in a sack they find in the corner. The sack is a *bag of transmuting* and allows the party to place anything they want within it. While the party stays within Castle Karn, nothing adverse happens to the contents of the bag. Once they leave the castle, however, the bag transmutes everything inside it into worthless junk (DMG p. 137).

5. THE FOREST ORACLE OF THE DRUIDS

(Map of The Grete Olde Woode, Area 10)

The trail from Castle Karn leads to the northeast for about ten miles. All the while, the forest and foliage becomes more prevalent and the sounds of wildlife increase.

The path leads to a glade. In the middle of this glade stands a huge oak tree, almost one-half mile in diameter. It rises above all the other trees of the forest, which seem to grow a respectful distance from it. At the foot of the tree rests a small marble building about 20' x 20'. Inside sits a figure.

The party has located the Forest Oracle. The giant tree itself houses the oracle, and the small marble building at its bottom is just a waiting area. Anyone with a small problem or who has come to pay his respects is received at the bottom. Those who have weighty matters to be handled are sent up to the fork of the tree, where an elaborate structure has been built to house the High Druid (See Map 10A).

OBTAINING AN AUDIENCE

The figure in the marble building is dressed in white. He smiles serenely and asks in a low, calm voice, "And what may I do for you, my children of the wood? We may be able to help you, the Golden Bough willing, but you will have to see the High Druid for help with weighty matters."

Once the party explains what they need, the figure (Druid; Lvl 2; AC 4; MV 12"; HD 2; hp 8; #AT 1; Dmg Nil; SA/SD None) looks puzzled and nods his head. If the party appears willing to see the High Druid, the Druid in the marble building offers to get them an audience. He disappears through a rear door, and returns in a few minutes.

DISARMING FOR THE HIGH DRUID

"The High Druid grants you an audience," he says, "but you must first remove your weapons. Only golden sickles are permitted in His Highness' presence."

Only the party members who disarm will be allowed to see the High Druid. If any threats are made, he summons the Golden Guard. The golden sickle symbolizes the Druidic order to which the inhabitants of the tree belong.

The Golden Guard consists of Druids of Level 5 or higher who protect the sanctuary. They disarm the remaining members of the party without violence. If necessary their leader will animate the ivy surrounding the tree so it will pin the adventurer's arms to their sides while the Golden Guard disarms them. They will always surprise PCs and NPCs.

TO THE HIGH DRUID

A Druid lets down an old, woven, rope ladder from above. At the top of the ladder, about 140' above ground level is a platform roughly seven feet in diameter (A). From this platform a suspension bridge of ropes and a wooden walkway (about 2 feet wide) goes to the next circular platform (1).

This platform is one of two areas where the Golden Guard is quartered. Walkways lead off this platform to either side and straight ahead. The platforms do not all lie on the same level, some being as much as 15 or 20 feet above another level. The druid escorts the party straight ahead, and brings them to the edge of the main platform (9). (See Area 10 Map.)

PLATFORM OF THE HIGH DRUID

A sprig of mistletoe floats in a small bowl at the entrance to this platform. When the Druid passes through, he dips the mistletoe in the water and sprinkles it to the four directions.

This 60' x 40' platform is constructed like the hall of a manor house. At the northern end, an old man sits in a highly polished but unornamented chair. His great white beard flows down onto his snowy robe. He wears a necklace composed of golden oak leaves and acorns, with a golden sprig of mistletoe as its ornamentation.

This is the High Druid (Lvl 12; AC 2; MV 12); HD 12; hp 61; Dmg 1-6; SA *confusion*; SD As druid). He will wait until the entire party is in the main sanctuary before he speaks. His voice is pleasing and well-modulated. Mistletoe dipped in water is a symbolic gesture of the continuance of life.

THE HIGH DRUID SPEAKS

"I hear you have journeyed quite a way. My friend," the High Druid points to the man who stood in the marble sanctuary below, "informs me you have come into the heart of the Great Olde Woode to seek wisdom and information." He is silent a moment, "How is it that I can help you?"

If the party relates its story without exaggeration, and includes that they aided the nymph and especially the dryad, the High Druid acts pleased. He motions for them to be seated on the floor at his feet.

If the party lies to him about the nymph or the dryad, he knows it, and asks that person to leave until he has "rethought" the adventure and wishes to tell the truth.

A CURE FOR THE BLIGHT

The High Druid listens attentively, his face becoming grim. He then states, "It is well that such heroes as yourselves have come. Lately we have been bothered by many things in the Great Olde Woode." He reaches behind his chair, pulls out a large bottle, and gestures toward it, "This is a potion which will help your crops. It is a potion of *growth* mixed with a potion of *cure disease*. If it is properly diluted and applied to the farmlands, the damage should be reversed. Surely my old friend Delon will know how it is done. I give this gladly to you for the good of the Downs—if you will do me a small favor as a sign of your good will."

The High Druid points to the west. "It has come to my attention that there are those who are despoiling land within a day's journey of this sanctuary. I do not blame the animals, for it is their nature to hunt and kill. I do not object to that. I do object to the goblins who would gather the great wolves and use them to unleash their terror on others who live in the woods. That such would happen almost within sight of the Golden Boughs is unheard of."

He sets the potion down before him. "If you rid these sacred woods of the goblins who desecrate them, this potion is yours," he says.

The High Druid is unaware that the party has already found the goblin hide-out unless the party tells him. The party must return to the goblin camp. This time they face goblins who are waiting and prepared to attack. If the party refuses to help the Druids, the High Druid asks that they prove they are from the Downs by undertaking this task.

The High Druid does not send along any help, as there are not enough members of the Golden Guard to protect both the sanctuary and the surrounding area, much less go off on a war party. He *blesses* the members of the party and their swords, (p. 43).

6. BACK TO CASTLE KARN

(Map of The Great Olde Woode, Area 9)

Shadows have grown among the trees. Passing clouds darken the sun, bringing temporary twilight to the forest. No animals call or scurry nearby.



The road back seems threatening, although it is not actually any more dangerous than it was when the party first came this way. It takes roughly one-half day to return to the castle and prepare for the attack.

IN SIGHT OF THE CASTLE

The spire of the castle looms darkly against the sky and the castle itself soon comes within sight. A guard stands by the front gate and drawbridge—a goblin with a sword and shield. On the north wall stands another guard, as well as on the south and east walls.

There should be no doubt about it. The 20 goblins and their leader (AC 6; MV 6"; HD 1-7 hp; hp 5 each; #AT 1; Dmg 1-6 [sword]; SA/SD None) are ready for a fight. They are aware that their castle was invaded. At first it appears that there is little way into the castle, but the east wall is mostly rubble, and not guarded.

THE CASTLE INHABITANTS

Inside the walls of the inner ward, a guard stands on the stairs to the tower. Another guard stands at the door to the main building which most of the goblins are using as barracks. There is no guard on the building (Area D) where the worgs appear to be quartered.

All guards are armed with a shield, spear, and a sword. Guards will spot an intruder on a 1 on 1d6. Roll separately for each intruder.

Including the goblin leader and the six guards, there are 21 goblins. The remaining 14 stay in the main hall. In an attack, all guards respond on the first round (if they are alive). The goblin leader responds on the third round. On the fifth round, seven goblins come out of the main hall to assist. For the next four rounds, one goblin comes out, and on the 10th round, the last three goblins come out of the main hall and fight with their comrades.

When the leader comes out of his tower, he yells something in Goblin. The worgs answer with a long, loud howl from their kennel (AC 6; MV 18"; HD 3-3; hp 21 each; #AT 1; Dmg 2-8 [bite]; SA/SD None).

From rounds five to nine, one worg exits the kennel during each combat round. The worgs will rarely attack a character that another worg attacks. Both worgs and goblins fight until the party is wiped out, or until exterminated themselves.

If, in the ensuing combat, any adventurer casts a *sleep* spell on the main goblin group, one of those left awake attempts to wake his sleeping comrades while the rest of the goblins fight. He may shake one awake each round, but he must spend a round going from one goblin to another. Each goblin, upon awakening, takes one additional round to become fully awake. In a good turn, a goblin going frantically from one comrade to another could awaken five others.

When all the goblins and worgs have been killed, the party may search their bodies. The goblins have 1-20 gp each. If the party looted the area prior to going to the Forest Oracle, there is no other treasure. Otherwise, they find several jars which contain 200 gp, 500 sp, and 10,000 cp and a pearl necklace worth 750 gp.

7. RETURN TO THE FOREST ORACLE

The journey back to the Golden Boughs (the Forest Oracle of the Druids) goes quickly. A Golden Guard at the base of the tree sounds a bird call and says, "Welcome back, brave adventurers. The High Druid awaits your return."

If any party member is injured, the High Druid will send for a healer. He administers a liquid from a small vial to each, a form of medicine to help heal their wounds.

If necessary, the healer will use *cure light wounds*, *cure critical wounds*, and *reincarnate* to bring the party back to a strength where they could reasonably make the journey home.

A CHANCE TO REST

"If you wish," the High Druid says, "you may stay here a few days, healing yourselves. I would not begin such a potentially hazardous return journey unless I were healthy. I think your return trip will be dangerous enough for the unwary—even the unwounded—without adding further complications. You may stay or leave as you see fit, the choice is yours."

As soon as the party is rested, the Druid sees that they are safely on their way back to the Downs. The High Druid will once again *bless* their swords and them (PH p. 43). The High Druid gives any Druid who is a member of the party a golden sickle before the PCs leave for the Downs.

LEAVING THE DRUIDS

"Go in peace," the High Druid says, blessing the party. "I advise you to use the lower river crossing. I hear that orcs mass to the west of the Wild River upper ford, waiting for you. It would not be safe to go that way. An old trail, just below the ruins of Castle Karn, leads to another ford. I wish you a safe journey."

The party has provisions for the way home, and has accomplished its task—securing a potion from the Druids (now separated into four waterskins, holding a quart each). The road seems straighter and smoother.

8. THE BUGBEAR TRAP

(Map of the Great Olde Woode, Area 11)

Just to the west of Castle Karn, an old trail leads to a ford in the river. The High Druid said it goes southward, crosses the Wild River, skirts one of the Dragonteeth Mountains, and then turns west through a pass in the Dragonteeth Mountains to their western side. From there, travellers can cross the Old North Road, or take it north to Bolo's inn and then go west to the Downs.

About six miles down the old trail to the river, each party member should make a surprise roll. If anyone is successful, he sees something orangish-brown and about 7 feet tall on the path ahead. The figure disappears into the bushes at the side of the trail.

If the party does not successfully roll for surprise, they walk down the path and into a trap laid by some bugbears. Only the leader (AC 5; MV 9⁺; HD 4+1; hp 25; #AT 1; Dmg 2-8 [flail or sword]; SA Surprise on a 1-3; SD None) and three bugbears (AC 5; MV 9⁺; HD 3+1; hp 18 each; #AT 1; Dmg 2-8 [clubs, maces, or daggers]; SA Surprise on 1-3; SD None) wait here. The other bugbears remain in the bugbears' camp.

If the party has surprise, they may attack the bugbears. If the bugbears have surprise, they attack first. It is possible for neither party to have surprise. If the battle goes against the bugbears, their leader breaks off combat and runs back to the bugbears' camp to get the others. The three bugbears he returns with all carry battle-axes and daggers.

The camp of the bugbears lies roughly 100 yards off the southeast side of the road in a small clearing (11A). Since this is a raiding party of bugbears, there are no females or young along. In the camp of the bugbears, there will be a *suit of mail +1* which is human-sized. The bugbears' treasure is 200 pp, 500 gp, 150 ep, and a silver-tipped (non-magical) spear.

9. CROSSING WILD RIVER

(Map of The Great Olde Woode, Area 12)

The forest trail is smooth, and the day is warm and pleasant. The sound of running water echoes throughout the forest ahead.

The Wild River appears somewhat tame here. The shore is broad, and although the water runs swiftly, there is none of the mad dash and white water which were present at the first river crossing. No bridge spans the river which is almost one and a half miles from bank to bank. Scores of prints on the trail—hoof prints of deer, paw prints of some medium-sized forest animals, and some human footprints—indicate that this is a common crossing. The water looks no more than two to three feet deep at most.

When the west bank of the river is 20 feet away, large, green creatures with black and dark brown splotches move from the brush on the shoreline. They appear wet and slimy.

These giant frogs surprise on 1-4 on 1d6 (MM p. 41). There are eight frogs (AC 7; MV 3^{+/9⁺}; HD 1-3; hp 10 each; #AT 1; Dmg 1-3/1-6/2-8 [blow/blow/bite]; SA Uses its sticky tongue to hit at +4, and on the next turn it will attempt to swallow its prey; SD None). These frogs can swallow any opponent on a result of 20 (1d20). Anyone swallowed may attempt to cut himself free if he has an edged weapon and can roll an 18 (1d20) or higher. If badly wounded (up to 2/3 its hp), the frogs retreat.



C home again

1. DRAGONTEETH CROSSING

(Map of The Greate Olde Woode,
Area 13)

The trail runs south along the slope of the Dragonteeth Mountains. Eight miles below the ford, the trail turns sharply northwest. It then follows a slight uphill turn into a valley flanked on both sides by the Dragonteeth Mountains.

The weather becomes cooler in the valley. For the high mountains, this is not unusual this time of year. The skies grow slate gray. A gentle snow begins falling, blanketing the region. After a couple of hours, with four inches on the ground, it stops. Snow covers other high passes, too, but in a day or so, it should melt. Passes are not usually blocked with snow until much later into the winter.

As you continue, the valley begins to narrow. In the past, boulders have fallen from the mountainside and lie across the tapering path, but they are not very difficult to get around.

Night comes suddenly in the valley. The sun sinks below the rim of the mountain, and the shadows of evening close in. A small notch in the valley provides the best shelter possible. Three logs of wood lie nearby, dry enough to provide warmth and a cooking fire.

MIDNIGHT VISITOR

Around midnight, a strange cry echoes throughout the valley, a howl which sounds almost human. It appears to come from the mountains, but from which side or how far up is not clear.

The party hears no other noise. This cry seems to have silenced all other animal noise. After 15 minutes, the normal night sounds resume.

FOOTSTEPS

An hour before dawn, loud, crunching footsteps circle the camp. The steps are slow and deliberate.

Should any of the party attempt to follow the footsteps, the footsteps fade away at a great speed, but without the usual clatter and commotion of someone running.

YETI FOOTPRINTS

In the snow, a trail of footprints larger than man-sized circle the camp. In several places the prints stop, and are deep and blurred as if the maker of the footprints was standing still and listening, or watching.

These footprints were made by a sub-adult Yeti whose home lies on the northern slopes of the mountain to the west.

The party members must each roll percentile dice. They spot a strange creature if they roll 5% or less per level above first. Thus, a second level character must roll 01-05%, third level, 01-10%, etc. If no one is successful, the creature surprises the party.

THE YETI ATTACKS

A large, white-furred creature rears up from a snowbank east of the camp. Snarling in rage and beating his chest, he charges. He swings his enormous arms in a wide circle, attempting to grab whomever he can.

The creature is a sub-adult yeti (AC 5; MV 15"; HD 3; hp 21; #AT 2; Dmg 1-6/1-6 [claw/claw]; SA Yetis have 2 clawing attacks, and if either scores a 20, the yeti has succeeded in squeezing his opponent for an additional 2-16 points (2d8) of damage; SD Impervious to cold).

The yeti has shadowed the party most of the way through the valley, and has decided to attack now, before the party leaves.

The yeti attempts to carry off a member of the party, determined by random die roll, by concentrating his attacks on that person. If the yeti successfully hugs his victim, he seeks to break off combat the next round and flee to his lair. The PCs may each attempt to hit him as he retreats at full speed.

The yeti will do no more damage to his victim until he reaches his cave. The victim will have a chance to escape on the way to the yeti's cave if he rolls his dexterity or less. If the victim does not make a successful dexterity roll, the yeti will throw him to the ground inside his cave and wait on a ledge before the door. He attacks the first pursuer to approach, fighting to the death. The party can find the cave if they follow the yeti's tracks. This cave hides the yeti's treasure which consists of 1,500 gp, 300 ep, 1,000 sp, 15 cp, 12 diamonds (200 gp each), and two daggers +1. A potion of healing is contained in a small, light blue bottle, and a wand of frost lies discarded in a corner (See Area 13 Map).

Should the party decide not to pursue the yeti, the victim must save vs. Death or die horribly. A successful roll indicates that he manages to escape without harm. In two hours he finds the rest of the party.

The yeti will attack until it is able to claim a victim, or until chased to its lair and slain.

2. THE LAST OF THE DRAGONTEETH MOUNTAINS

(Map of The Great Olde Woode, Area 13A)

From the eastern edge of the mountains, the end of the valley looms in sight. The air warms, and the snow melts. The fringe of the Great Olde Woode lies ahead.

The distant sound of flapping wings becomes louder, and some medium-sized winged creatures hover overhead. They seem bird-like, but have the heads of deer with great black horns. Their feathers are green, and two of them have light blue breasts, while the others are drably colored.

There are two male and two female perytons (AC 7; MV 12"/21"; HD 4; hp 18 each; #AT 1; Dmg 4-16 [horns]; SA +2 to hit; SD *weapon +1* or better to hit). Each creature chooses a single victim and attacks him. The perytons, who fight to the death, will not all attack a single party member. If a party member dies, the peryton tears his heart out and flies away with it. Once three perytons have been killed, the remaining one breaks off combat and flies away, making enraged sounds as it goes.

THE PERYTON NEST

High above in the rocks, a peculiar structure of sticks juts out over the edge of a boulder.

The perytons nest in this structure. It takes two hours to reach the nest and return. No perytons left alive bother the party. The nest contains 2,000 ep, 8 bracelets (600 gp each), and a battle axe +1.

3. LEAVING DRAGONTEETH CROSSING

The walls of the valley gradually diminish, revealing the forest below. The Great Olde Woode spreads out like a carpet to the north and west. To the south, the forest skirts the mountain chain, and to the southwest it stops and rolling vales begin. The path leads down into the forest and goes west.

The party may follow the path, which leads to the Old North Road. No trail takes them directly back to the Downs unless they choose to follow the Old North Road until it comes to Bolo's Hungry Traveller Inn. No matter which road the party decides to follow, they have to pass through some woods to do so.

4. RINALDO

Ahead, in the middle of the path, waits a young man. He rests his hands on his hips. His gaily-colored clothing and the bandana around his forehead contrast with his pencil-thin, black moustache. He has a ring of what appears to be pure gold in his right earlobe. He flashes a dazzling smile, and bows low, in an exaggerated fashion.

"Good day, hardy travellers, I am Rinaldo. I see that you have had an interesting journey. I hope you are well." His manner seems to be one of genuine concern.

"You do not know me, but I have heard of you. Not too long ago I was at Master Bolo's inn, and some passers-by related your story. I put two and two together, and some very strange occurrences seemed to suddenly make sense. I tried to catch up to you, but the caverns beneath the Dragon-teeth Mountains are now impassable. I figured the best way to run into you was to meet you here." He shrugs his shoulders, "And so here I am."

If the party questions him, he will smile and answer in a cryptic, but unoffensive fashion. Rinaldo means to be likeable. Rinaldo (Fighter; Lvl 3; AC 7; MV 12"; HD 2; hp 12; #AT 1; Dmg 1-6 [dagger or shortsword]; SA/SD None but has a Ch of 15) carries a dagger concealed in his boot.

Rinaldo is very sure of himself. He appears to know much about the party they may have felt was "unknown," but which a clever and resourceful person could ferret out by simply observing and collecting gossip.

CONVINCED TO SEE MADAME RIVA

"As soon as Madame Riva heard of you, she said to me, 'Those are the ones I wish to see.'" Rinaldo motions with his hand, and six large, brightly dressed men step from the thickets.

"Do not be alarmed. They are here to help grant you a safe passage to Madame Riva. She has a business proposition for you. I think you will find it quite profitable to hear her out." Rinaldo glances about nervously. "Come," he says, "it is not safe to tarry in this portion of the woods."

Although these men (statistics are the same as Rinaldo's) are well-armed, they do not directly threaten the party with their weapons. If the party asks who Madame Riva is, Rinaldo simply responds that the party will know soon enough.

The men with Rinaldo are here as protection, and to assure the party visits Madame Riva. Above the party, well-hidden in the foliage, is a large net which will drop if the party tries to resist going with Rinaldo. The party will then be taken to Madame Riva. He gives the party his word that they will not be harmed if they hear her out, and allows them to keep their weapons. As a member of the Travelling People, to give his word, and to take someone's word, is a deal which he feels is binding unto death. As usual, the DM will roll for random encounters, and if a wandering monster is encountered, the seven Travelling People will help the party vanquish this creature.

5. MADAME RIVA'S CAMP

(Map of The Greate Olde Woode, Area 14)

A clearing at the southern fringe of the Greate Olde Woode reveals a camp full of life and happiness. Everyone is brightly clad in a variety of silken garments. Most are dark-haired and have black, flashing eyes.

Many wooden wagons form a circle around the encampment. The wagons are painted in bright reds, greens, yellows, and blacks. Most have a door and a back step, although a couple of the entrances are covered over only by a leather door-apron. Small windows line either side of the wagons.

In the center of the camp is a communal feast area. A large table is spread there, and various members of the Travelling People stop and take an apple, bread, or a piece of venison as they pass by. "You are no doubt hungry. Go and eat and drink while I see if I can find Madame Riva and inform her of your presence."

The food is not tainted, poisoned, or tampered with. The party may satisfy their hunger and thirst. They are allowed free rein in the camp, but are not allowed to leave.

MADAME RIVA

Rinaldo returns. "Madame Riva wishes to see you now. She is this way," he says, starting toward the largest wagon in the encampment.

Madame Riva's wagon is bright red with a yellow band and black wheels. On each side of Madame Riva's wagon is a big silver star. Sitting on the back stoop is a thin, old woman. She has dark, piercing eyes and a cynical grin. She holds herself erect, and acts in no way enfeebled.

"Good day, young folk," she says. She nods to herself, saying, "You'll do, or I miss my mark. Please be seated," she says, motioning toward some logs. "It is not as fancy as town-folk chairs, but it keeps you off the cold ground. It's a hard enough world this is, without making it any harder than it must be." She pulls out a long white pipe and lights it, inspects it carefully, and then looks up again. "You've eaten? We cannot offer much, but we share with those who are our guests." She points the mouthpiece of the pipe at your party. "You've been beyond the mountains to see the Druids?"

Madame Riva (Magic-user; Lvl 4; AC 9; HD 5; hp 21; MV 12"; #AT 1; Dmg 1-4 [hand]; SA *charm x2* and *sleep x4*; SD *ring of invisibility*) nods and comments on how bad the weather is for travelling if the party answers yes. If the party answers no, she smiles and says, "Canny. I like that," and continues her questioning. She is just passing the time of day until she can bring up the real subject she wants to talk about.

THE PROPOSAL

Madame Riva draws deeply on her clay pipe, and exhales slowly. She is the very soul of patience and grandmotherly chatter, yet she knows many surprising things. Finally she says, "You are from the Downs," and ignores any arguments to the contrary. She smiles sadly, "I was through the Downs not too long ago.

"Just before the Travelling Folk entered the Downs, we encountered Olot the ogre. We treated him well. He repaid us with lead when we had given him gold." She smiles craftily. "In short, young folk, we gave him the hospitality of the camp, took his word, and he stole from us."

"When we sent some men to regain our possessions, they were slain by a big man that guards Olot's dwelling. No member of the Travelling Folk is able to approach the dwelling to reclaim what is ours. That ogre demands payment from us for our own possessions!" She puffs angrily on her pipe.

Slowly she calms down. "That is why, young folks, when I passed through the Downs I asked for silver. The people there would not give me any. I needed silver to buy back what had been stolen from us. I thought if I threatened the Downs, they would pay. They did not—I cursed them in my anger. It should have been Olot!" She checks her pipe—it has gone out. She empties the pipe and puts it away.

"Here is what I propose: you do me a small service, and I will lift the curse on the Downs. If you wish not to deal with me, I will sell you a cure for the curse that blights The Downs."

If the party tells Madame Riva they already have a cure for the curse, she tells them it will not restore this year's crops. She will restore the crops if they return the pegasus to her.

Madame Riva is sincere. She waits patiently for the party to give her an answer. Whether they accept or not, she tells them the following story.

OLOT'S TRICKS

"Olot is a cunning, devilish ogre. We met him in the woods, and he did not harm us, so we gave him the hospitality of the Travelling Folk. He repaid us by stealing Silverwing, a pegasus we captured and were taking south for a lord. He took Silverwing to his cave, and demands that we pay 20,000 gp for his return. We do not have that kind of money.



Olot has found a flesh statue which he has empowered to kill and harry only Travelling Folk, so we are unable to reclaim the pegasus." She spits on the ground, "Bad luck to him, I say! Anyway, I feel that since Olot is so clever, perhaps his own cleverness could be turned against him. What if some bold people who were not Travelling Folk went there to reclaim my Silverwing?" She laughs at her own cleverness, "What if you went there to reclaim him?" She leans forward, anticipating an answer.

Madame Riva has made her opening offer. If the party presses her, she adds that in addition to lifting the curse on the Downs, she will throw in a good horse for every member of the party. If this is not enough, she offers to let them have all of Olot's treasure that does not belong to the Travelling Folk (she had intended to keep it all for her people). If they still refuse, she pretends to be resigned, and offers to have each of the members be the guest of honor at a party that night.

At the party, there is much eating and drinking. Each member of the party finds that a member of the Travelling People of the opposite sex is sitting next to him. These Travelling People are magic-users, Level 3, who attempt to *charm* their partners into going to Olot's cave to recapture Silverwing. All party members must save vs. Charm or be charmed. If any party member is *charmed*, Madame Riva will have a small twinge of conscience, and offer to throw in 100 gp, on return, to each party member who goes to Olot's lair. If some or all of the party manage to avoid being *charmed*, they are free to leave the gypsy camp.

LEAVING FOR OLOT'S LAIR

Rinaldo offers to guide the party to Olot's cave. He explains, "Since you are going to do such a great service, you deserve all the help you can get."

Madame Riva smiles. "Be careful," she tells everyone. She has a package wrapped in silk. When it is unwrapped, there is a beautiful silver-bladed scimitar. Madame Riva says, "This may help slay Olot."

This scimitar is a magic sword. It is +2 against ogres only. Of course, no one in the Travelling Folk can get close enough to Olot to use it. She intends it as a gift.

6. OLOT'S LAIR (Map of The Greate Olde Woode, Area 15)

The road Rinaldo takes is winding and little-travelled. Weeds threaten to cover it totally. The road goes through the forest, gradually turning uphill and due west. As the hill becomes higher, the steep path becomes narrower. The trees thin to reveal the top of the hill. Suddenly Rinaldo stops. "You are almost there. Just around this bend is the big man. I will wait here for you. Do you want me to watch your valuables so you will not be encumbered?"

Rinaldo is genuinely concerned about the party's maneuverability. He also feels that if the party does not survive, he can take their belongings back to Madame Riva and perhaps raise some of the money that Olot requires. The Travelling Folk may then be able to purchase Silverwing's freedom from Olot.

THE PATH INSIDE OLOT'S LAIR

A path snakes upward. Sheer walls line the path, and a coat of treacherous ice covers the stony surfaces.

Just around the bend, the path widens. Standing in the middle of the path is a man over seven feet tall and criss-crossed with many scars and old wounds. He faces the party, his eyes unblinking. Only his hands move, clenching and unclenching when he sees you.

This is a Flesh Golem (AC 9; MV 8"; HD 40 hp; hp 40; #AT 2; Dmg 2-16/2-16 [fist/fist]; SA Can do 1 point structural damage to wooden structures every three rounds; SD Normal weapons do not harm him, but magical weapons will do normal damage, and electrically-based magic spells restore damage in direct relation to the number of dice damage normally done). This Flesh Golem is a left-over from a castle that Olot found in ruins. The magic-user was long dead. The Golem now guards the entrance, but does not

attack unless a member of the Travelling People appears or unless the person has struck the Flesh Golem with a magical weapon. It fights until killed (MM p. 48).

The Gas Trap

Once past the Flesh Golem, the path runs straight north for approximately 50 feet, to the west for 40 feet, and finally turns back north.

Midway down the path, about ten feet from the entrance is a gas trap, containing *slowing* gas. The trap is activated by pressure. Its pressure plate covers a 10' x 20' area. The weight of two or more party members will activate this trap. For the next two turns, all those affected must move at half normal speed. To avoid the effects of the gas, the party members must save vs. Poison.

The Pitfall Trap

The path goes straight north for 60 feet, and runs east for 40 feet before turning back north.

A 10' x 20' *pitfall trap* waits for the unwary, filled with one spear every two feet. The weight of one or more people activates this trap. Anyone activating it must roll their dexterity or less on 1d20. Those failing their dexterity roll land on a spear and take 1-6 points of damage as if stabbed by a spear. The trap does not reclose, and those seeking to cross it must jump. Once a party member falls into the pit, his friends may easily help him out.

The Water Traps

The path runs straight for 60' before widening to an area roughly 65' wide by 55' long. The path narrows and runs for 40' north before turning due east.

This widened area contains four traps. Party members might be wary of walking straight across, and seek to hug the walls to avoid any traps. The traps lie in each corner. Each trap is 20' x 15'. A clear path 10' wide runs down the center of the area. Any person stepping on one of these traps must roll his dexterity or less on 1d20, or fall into a pit which is 20' deep and filled with water. The edges of this pit are slick stone, making it hard for a person to get out without help. They may be pulled out if they have removed their heavy armor (plate). It takes one round to sever the leather

thongs which bind plate armor to its wearer. Those wearing armor lighter than non-magical plate armor need not remove anything to be pulled from the water. After four rounds in the water, the swimmer tires and sinks.

The Ball Trap

Beyond the pit and widened area, the trail runs straight for 45', and then back to the east for 30'. It turns north for 45' and ends in a cave mouth.

Twenty feet down this path is a *ball trap*. When party members step on the trap, a huge, round ball, eight feet in diameter, falls from above the cave's mouth and begins rolling. Party members may save themselves if they fall to the sides of the corridor path and save vs. Petrification. If the party members fail their saving throws, they receive 1-4 points of damage from the rock as they throw themselves to the sides of the wall. If the party attempts to outrun the ball, each member must make a successful dexterity roll for every 50 feet travelled. Failing this, they fall and may roll to the side of the path, but still receive 1-4 points of damage. The ball continues to roll down the tunneled pathway and falls to the side of the path outside.

THE MOUTH OF OLOT'S CAVE

No light comes from the mouth of the cave. The right-hand wall falls away 15' inside the cave. The left-hand wall falls away about 50' into the cave.

Once inside the cave, the party hears noises made by Silverwing at the back (north) end of the cave. What appears to be the left wall is actually a big rock. The rock, used as the door to this cave, hides Olot the ogre.

OLOT

Once inside, with a groan of rock on rock, the left hand wall moves and shuts the entrance way.

Standing there panting from exertion is a tall figure. Dressed in skins, he carries a gigantic two-handed axe. "I am glad you dropped in for dinner," he says, licking his lips and advancing.

This is Olot the Ogre (AC 5; MV 9"; HD 4+1; #AT 1; Dmg 1-10 [axe]; SA None; SD None). He has been waiting since the party first entered the path to his cave. He loves human flesh, and his larder (Area L on Area 15 Map) is getting low on choice cuts. The rock takes a combined strength of 30 to move.

Olot is 7 1/2 feet tall, black-haired, and dressed in green skins. His eyes glow yellow in the reflected glare of the party's torches. As he advances on the party, he attempts to keep his back to the wall.

To decide whom Olot attacks, as he is chaotic, assign each PC a number on the closest size die to the number in the party (4, 6, 8, 10, or 12) and then roll that die each round to see who Olot's victim is. Of course, he must be able to reach that party member in order to attack him, otherwise he attacks the closest opponent. While Olot fights, he makes little comments to himself as to how tasty the various members of the party look, and how good they will most likely taste in a stew. He tells the largest member of a party "You'll roast nicely. I can smell the gravy and hear the juices sizzling now." To the smallest member of the party, he comments, "It's too bad you're so puny. Out of consideration for my time and effort, you should have fattened yourself up before coming here to pester me. It's almost not worth the time it will take to clean and skin you."

SILVERWING

The cave has two exits. From the one to the north comes whinnying sounds. The one to the west is silent.

The exit to the north is where Olot holds Silverwing captive. The pegasus acts friendly to the party, but has been broken by gypsy riders and seems saddle-trained only if a gypsy saddle blanket or bridle of the Travelling People is put on him. He can be led, however. Once outside, he does not attempt to escape.

OLOT'S LARDER

The dark west cavern emanates a faint carrion odor. Torchlight reveals seven torsos hung like side-meat. This is the larder of Olot.

If the party investigates the room, they see that there is an area behind the larder where Olot lived and kept his treasure. His treasure consists of 9,000 gp, 1,000 ep, 2,000 cp, 3 pieces of jewelry, a potion of *giant control*, a potion of *invisibility* and scrolls of *protection from demons*, *protection from were-tigers*, *protection from magic*, and *protection from water elementals*.

If the combined strength of the party is insufficient to roll away the rock, Silverwing may be employed to help.

7. BACK TO THE GYPSY CAMP

The road back to the Gypsy encampment is not dangerous.

Madame Riva abides by all the terms of the deal she made with the party. She also presents each member of the party with a small silver medallion which allows any other Travelling People to aid them if they ever need help (regardless of charisma modifiers).

All of the party's belongings are returned to them, and Madame Riva asks if she can help them in any way. If the request is for food, etc., she grants it. She has a cleric cast a **cure serious wounds** on any member of the party who requires it.

Unless the party has a random encounter with a wandering monster, they should not have any encounters between the time they leave Olot's cave and the time they actually set foot back in the Downs.

8. RETURN TO THE DOWNS

The trip to the Downs is accomplished with little more than travel. The Downs looms in sight, as does the glory of helping this blighted, suffering land.

9. THE DOWNS

Delon the Mage very happily says, "We cannot thank you enough for what you have done. The land may once again thrive. We regret that we are unable to reward you more, but we have managed to find 100 gold pieces for each of you. If you ever need a home or a place to stay, the doors of the Downs will always be open to you."

the end

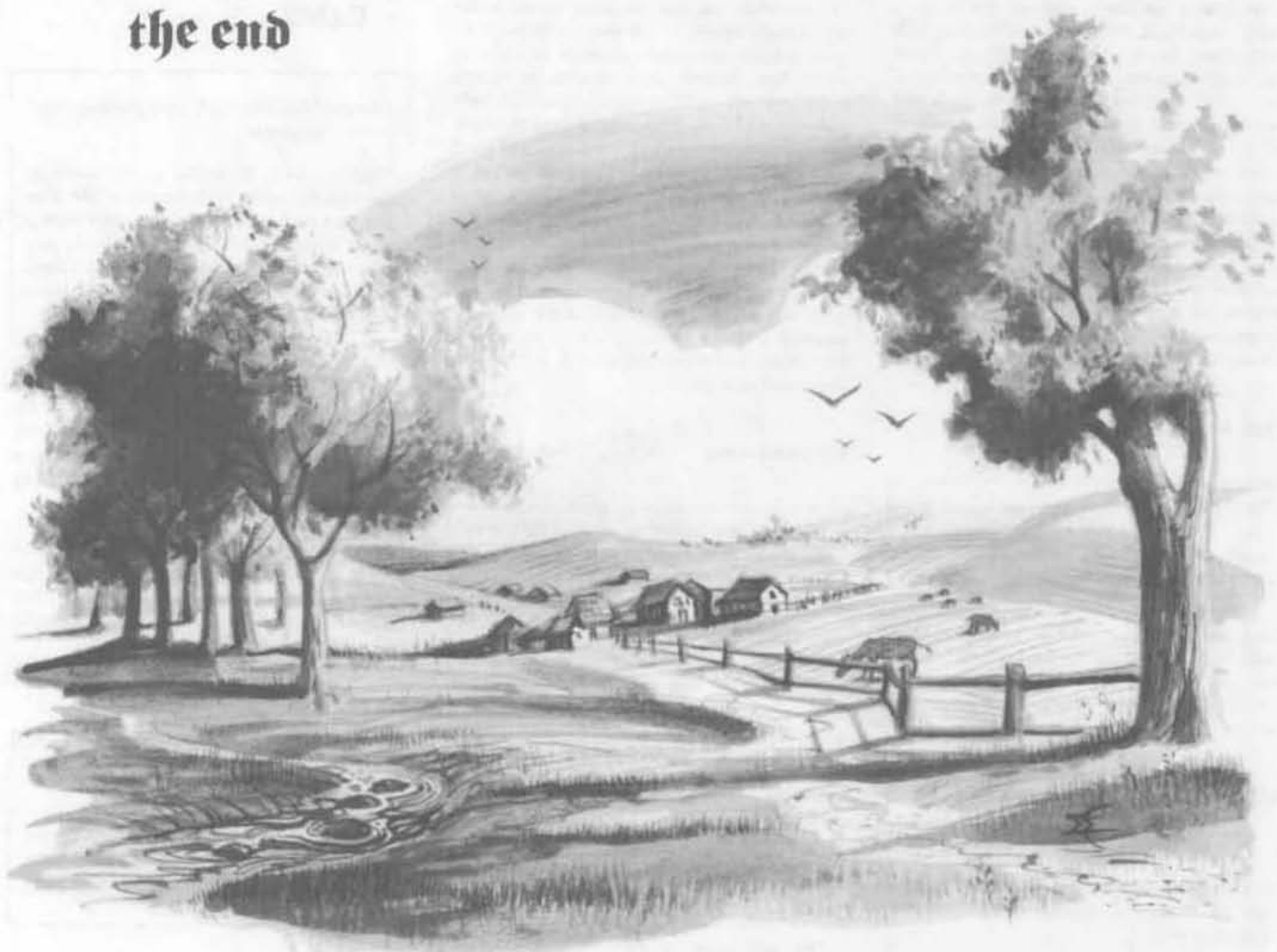

prerolled characters

Name	Class/Lvl	Race	STR	INT	WIS	DEX	CON	CHA	HP	EQUIPMENT
Alain	F3	Human	17	9	11	14	17	14	22	sword, chainmail and shield, longbow, 10 arrows, dagger, 24 gp
Conrad	F4	Human	18	10	11	13	16	12	30	leather armor, shield, sword, dagger, light crossbow, 12 quarrels, 30 gp
Mozz	D2	Human	14	15	17	15	14	12	14	leather armor, scimitar, scythe, <i>animal friendship</i> , <i>shillelagh</i> , <i>cure light wounds</i> , and 14 gp
Teketawk	MU3	Human	12	17	12	16	11	12	10	dagger, <i>sleep</i> , <i>unseen servant</i> , <i>web</i> , <i>potion of giant control</i> , and 15 gp
Hinfrette	MU2	Human	10	16	13	14	12	11	7	dagger, <i>sleep</i> x2, <i>magic missile</i> , 21 gp
Blint Brokenhaft	F3	Dwarf	18	12	12	10	14	8	19	chainmail and shield, war hammer, short sword, axe, 21 gp
Shard	F4	Elf	16	17	11	16	14	15	31	chainmail, sword, dagger, longbow, 12 arrows, 13 gp
Fazil	T3	Elf	15	14	13	18	14	14	14	leather armor, 2 daggers, sword, 50' rope, 10' pole, 25 gp
Fromo Freefinger	T2	Halfling	13	14	12	17	12	15	10	leather armor, short sword, dagger, sling and 12 stones, 30 gp

items common to prerolled characters

All characters possess a leather back pack, a waterskin (2 qt.), flint and tinder, 1 tallow candle, 2 torches, 2 weeks rations, a blanket, and a belt pouch the size of a small pocketbook, a spoon, and small bowl.

The Greate·Olde·Woode

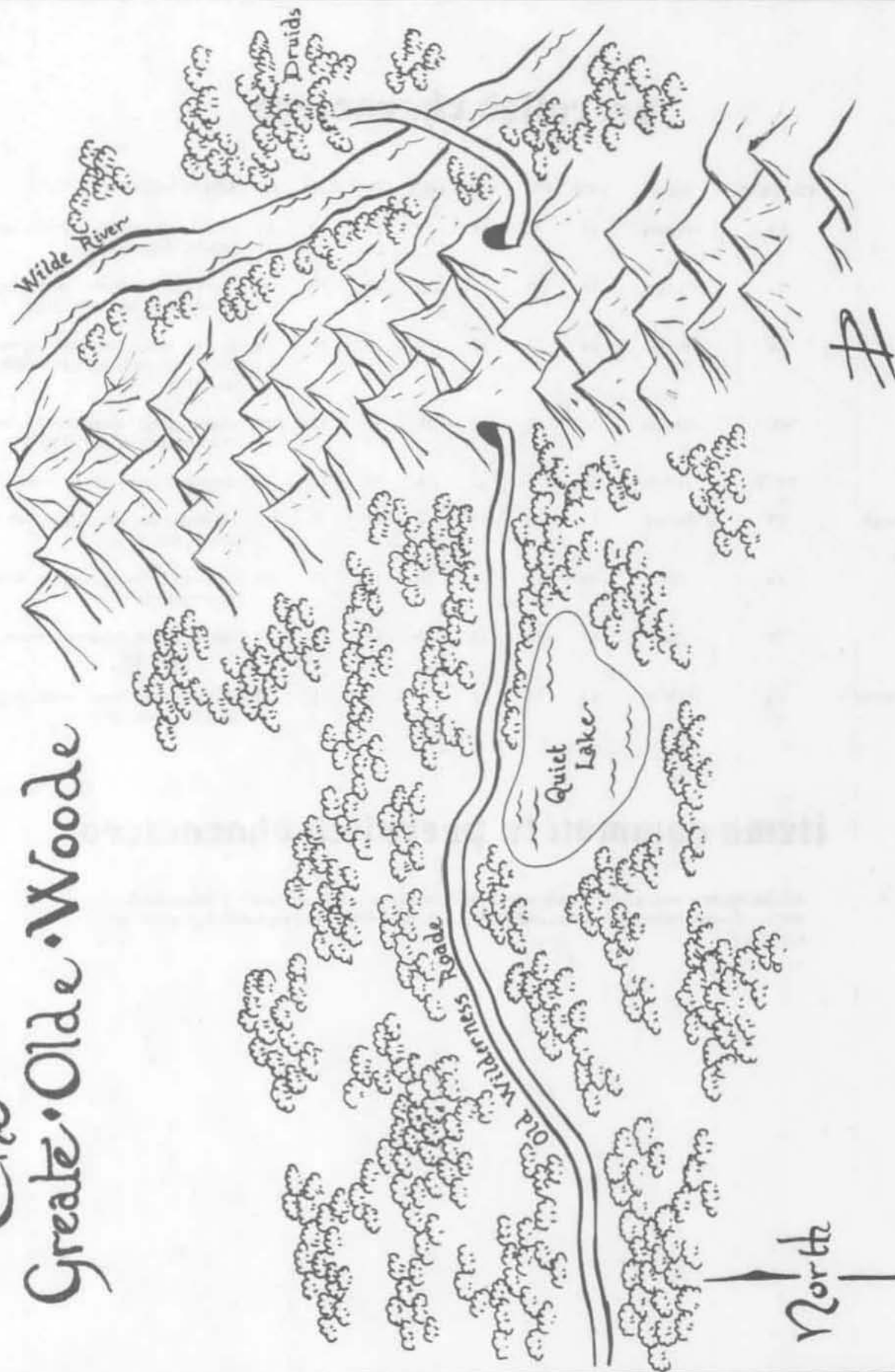

Tunnel Through the Horns of the Dragon Area 5

Key	
1. Empty Cavern	5. Dead End
2. Dwarven Ruins	6. Underground Lake
3. Empty Cavern	7. Dead End
3A. Mad Dwarf's Cavern	8. Orc Hide-out
4. Honeycomb Maze	

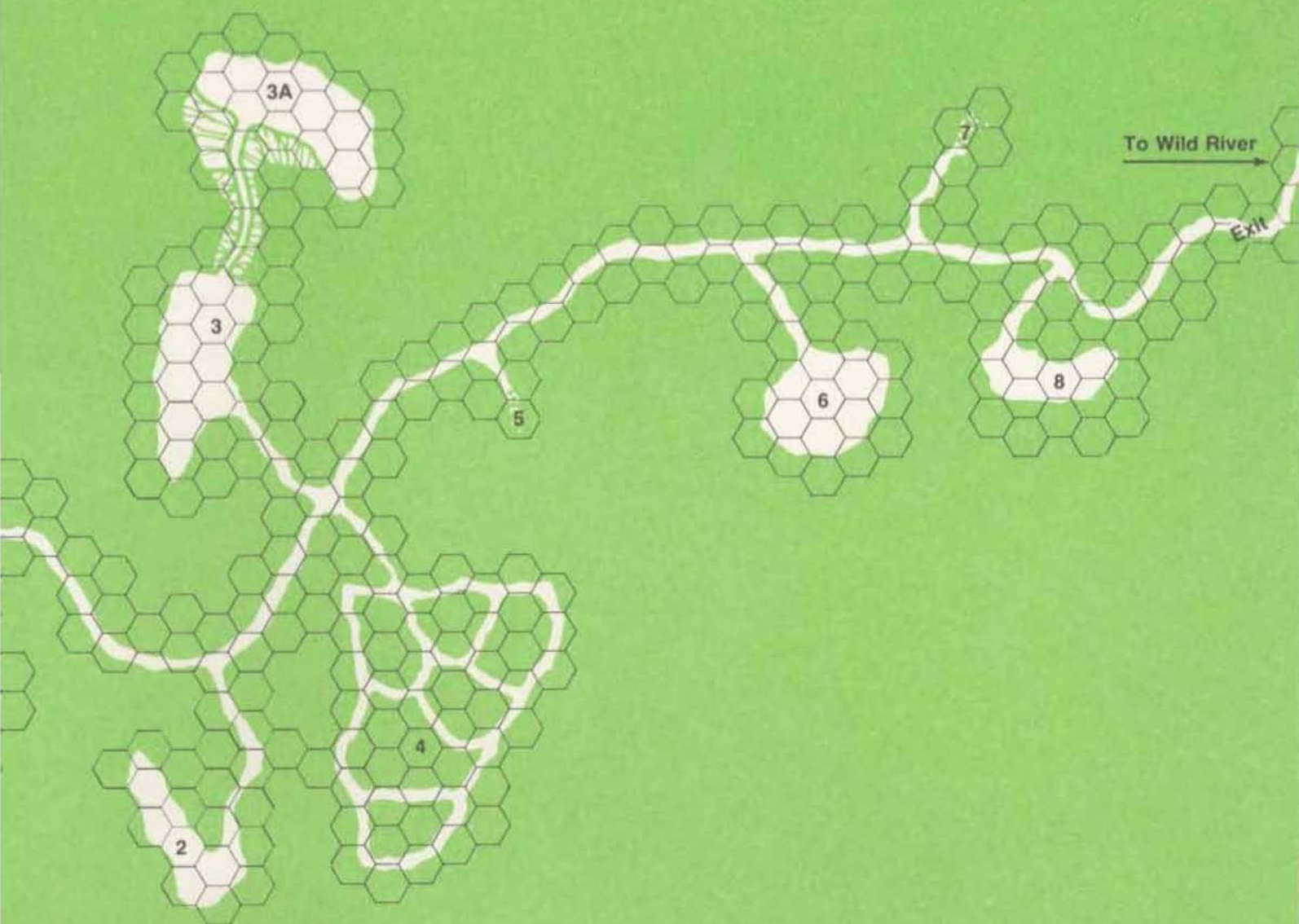

Advanced Dungeons & Dragons®

Official Game Adventure

the forest oracle

by Carl Smith

The land lies under a curse. Fruit drops to the ground, its pulp black and rotten. Leaves curl and wither on the branches. Animals flee the parched vale, or starve.

Long ago, the Downs prospered under the care of Druids. But the priests of nature have retreated deep into the woods and rarely show themselves. One old man claims that the Druids have the power to save the valley, if only someone could find their Oracle to seek help. Will you reach the Forest Oracle of the Druids in time? And if you do, can they really lift the curse?

Or does the answer lie elsewhere?

Only the most daring and cunning adventurers will save the Downs. For character levels 2-4.

© 1984 TSR, Inc. All Rights Reserved. Printed in U.S.A.

TSR, Inc.
POB 756
Lake Geneva,
WI 53147

TSR (UK) Ltd.
The Mill, Rathmore Road
Cambridge CB14AD
United Kingdom

ISBN 0-88038-103-5
394-53804-8TSR0600

